

MikroTik
routerboard
PRODUCT CATALOG Q3/Q4 2016



Contents

Why MikroTik?	4	CCR1072-1G-8S+	69
RouterOS.....	6	mAP series	71
MikroTik	7	cAP	73
MUM.....	8	wAP	75
Academy.....	9	hAP	77
mANTBox	11	hAP ac series	79
NetMetal 5	13	RB951 high power series	81
NetBox 5.....	15	RB2011UiAS-2HnD-IN	83
DynaDish 5	17	RB411.....	85
QRT Series.....	19	RB433.....	87
LHG 5	21	RB435G.....	89
SXT ac series	23	RB850/450.....	91
SXT 5.....	25	RB493.....	93
SXT 2.....	27	RB800.....	95
SXT LTE	29	RB953GS-5HnT-RP	97
SEXTANT G	31	RB911 Series.....	99
Metal.....	33	RB912.....	101
Metal 52 ac.....	35	RB922UAGS-5HPacD.....	103
Groove.....	37	mANT series.....	105
Groove 52 ac.....	39	mANT30 series.....	107
BaseBox	41	Sleeve30 Kit	109
OmniTik	43	quickMOUNT	111
CRS 8 Ethernet port series.....	45	R52HnD.....	113
CRS 24 port series	47	Wireless miniPCI cards	115
CRS212-1G-10S-1S+IN	49	R11e series.....	117
RB260GS series.....	51	48V Gigabit PoE converter	119
hEX.....	53	SFP transceivers	121
PowerBOX.....	55	GPON ONT module.....	123
RB2011 Series.....	57	FTC.....	125
RB3011 Series.....	59	Flex-guide.....	127
RB1100AHx2	61		
CCR1009 series	63		
CCR1016 Series.....	65		
CCR1036 Series.....	67		

Why MikroTik?

MikroTik provides routing and wireless equipment for all possible uses - from the customer location, up to high end data centres.

We have an extensive network of trained consultants, training centres and distributors in almost every country of the world.

Established in Europe in 1996, we have 20 years of experience in networking and wireless installations.

Our in-house developed RouterOS software now supports most common and many special features and we are constantly adding new customer requested features.

Build wireless links across seas, internet exchanges between countries, and secure tunnels between banks. MikroTik can do it all.

Reseller, trainer and consultant map

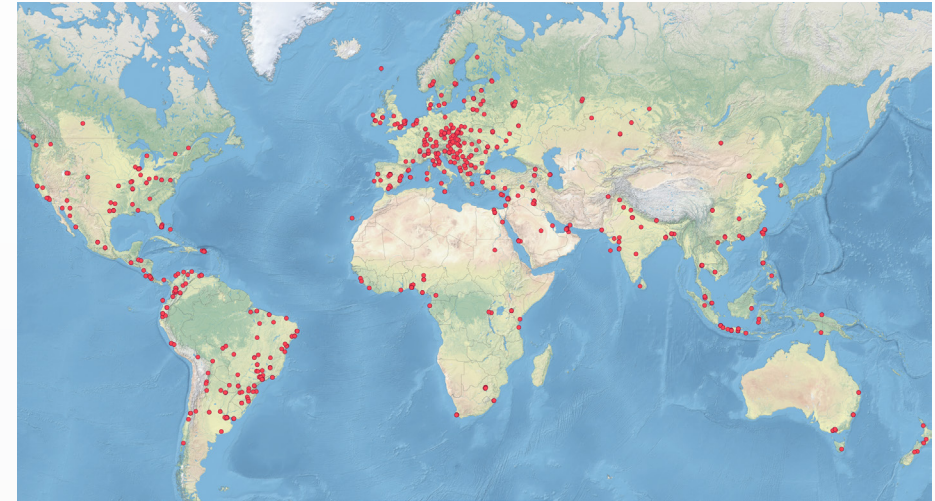

- Best price/performance
- Millions of RouterOS powered devices currently routing the world
- Twenty years of developing networking software and hardware
- Over 50'000 RouterOS trained and certified network engineers
- More than 4000 training classes in the last year
- World wide network of certified consultants
- Offering products that support simple CPEs to complex enterprise networks
- Thousands of pages of documentation, examples, application notes, and guides

RouterOS

MikroTik RouterOS is the operating system of MikroTik RouterBOARD hardware.

It has all the necessary features for an ISP - routing, firewall, bandwidth management, wireless access point, backhaul link, hotspot gateway, VPN server and more.

RouterOS is a stand-alone operating system based on the Linux v3.3.5 kernel, and our goal here at MikroTik is to provide all these features with a quick and simple installation and an easy to use interface.

- Powerful QoS control
- RIP, OSPF, BGP, MPLS routing
- P2P traffic filtering
- Bonding of Interfaces
- Stateful firewall, tunnels
- (R)STP bridging with filtering
- High speed 802.11a/b/g/n/ac
- Wireless TDMA (Nv2)
- WDS and Virtual AP
- HotSpot Plug-and-Play access
- WinBox GUI and Web admin
- Telnet/mac-telnet/ssh/console
- Real-time configuration and monitoring

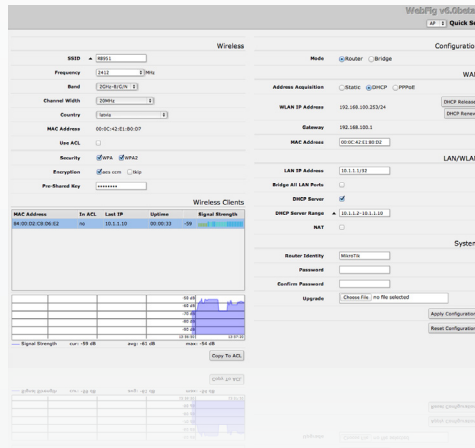

MikroTik

MikroTik is a router software and hardware manufacturer, that offers the most user friendly, up to carrier-class routing and network management solutions. Our products are used by ISPs, individual users and companies for building data network infrastructures all across the world.

There are millions of installations worldwide going back as far as 1996!

Our mission is to make existing Internet technologies faster, more powerful, and affordable to wider range of users.

- Based in Europe
- 160 employees
- Established in 1996
- 20th anniversary this year
- RouterOS in 1997
- RouterBOARD in 2002
- First MUM Prague, Czech Republic in 2006

MUM

MikroTik User Meeting (MUM) is a conference on MikroTik RouterOS software and RouterBOARD hardware. Ask questions, attend workshops, listen to presentations, talk with specialists and see interesting technology demos by MikroTik and the users themselves - all here, at the MUM!

The MikroTik User Meeting brings many MikroTik users together at once, so you can get the maximum information in the shortest time.

The MUM has taken place already 107 times, in 53 countries in all continents. Every year, more people attend these great events - every next event breaking the previous attendance record. More than 2500 people attended the conference in Indonesia in 2015! You should come too!



Academy

Colleges, universities, and schools around the world are starting MikroTik Academy programs to offer students Internet networking courses using MikroTik RouterOS as a learning tool. We are actively enrolling new locations weekly and looking for new applicants.

There are no charges from MikroTik for material, online testing, and online certificates associated with this program. MikroTik Academy program offers schools an excellent networking education program and program materials for little or no cost.

The program courses offer:

- a proven network education program
- official MikroTik RouterOS certification exams
- discounted (and free) hardware and free RouterOS licenses for training classes

If there is an educational institution near you that could be interested in the MikroTik Academy program, please contact us or forward this information to them.

Please contact us at training@mikrotik.com.

Official MikroTik Academy Web Page:
<http://www.mikrotikacademy.com>

MikroTik Academy application form:
<http://www.mikrotikacademy.com/apply>



mANTBox

The mANTBox is based on our new mANT sector antennas, but also has a wireless router built right in. Powered by the RB921 device, the mANTBox comes ready to use with everything included. The device uses a high speed 720MHz CPU and has a built in 802.11 ac/a/n wireless device with up to 31dBm output power.

Just like our mANT antennas, the mANTBox also comes in two sizes, a 15 dBi sector unit and a 19 dBi sector unit.

The mANTBox 15s is compatible with the SXT type mount, so you can use it with our durable and adjustable QuickMount systems. It comes with quickMOUNT PRO included. The mANTBox 19s comes with metallic U bolt type mounts.



Model	mANTBox 15s	mANTBox 19s
Product code	RB921GS-5HPacD-15S	RB921GS-5HPacD-19S (International) RB921GS-5HPacD-19S-US (USA)
CPU	QCA9557 720MHz	QCA9557 720MHz
Size of RAM	128MB DDR2 300Mhz	128MB DDR2 300Mhz
Data storage	128MB NAND	128MB NAND
10/100/1000 Ethernet ports	1	1
SFP cage	1	1
Wireless	Built-in 5GHz 802.11ac, dual-chain	Built-in 5GHz 802.11ac, dual-chain
PCB temperature monitor	Yes	Yes
Voltage monitor	Yes	Yes
Power input	jack: 8-30V DC, PoE in: 8-30V DC	jack: 8-30V DC, PoE in: 8-30V DC
Power consumption	13W	13W
LEDs	8	8
Beeper	Yes	Yes
Operating system	MikroTik RouterOS, Level 4 license	MikroTik RouterOS, Level 4 license
Antenna gain	15dbi	19dbi
Frequency range	5.17 - 5.825GHz	5.17 - 5.825 GHz (International) 5.17 - 5.25 GHz and 5.725 - 5.835 GHz (USA)
Polarization	Vertical and horizontal	Vertical and horizontal
3DB Beamwidth - azimuth	120deg	120deg
3DB Beamwidth - elevation	10deg	5deg
VSWR	1.43 typ, 1.8 max	1.43 typ, 1.8 max
Port to Port isolation	>40dB min	>40dB min
Front-to-Back ratio	>30dB	>30dB
Cross Polarization	>30dB	>30dB
Weight	Package: 1.35Kg Unit: 816g	Package: 3.01Kg Unit: 1,36Kg
Dimensions	140x348x82mm	152x598x78mm

Device	mANTBox 15s / mANTBox 19s
TX/RX at MCS0	30dBm / -96dBm
TX/RX at MCS7	27dBm / -77dBm
TX/RX at MCS9	22dBm / -72dBm
TX/RX at 6Mbit	31dBm / -96dBm
TX/RX at 54Mbit	27dBm / -81dBm

NetMetal 5

By supporting the 802.11ac wireless standard, the NetMetal allows to use datarates of up to 1.3Gbps (for the T models), 256-QAM modulation and 20/40/80MHz channels. With its huge speed improvements, 802.11ac opens up new possibilities.

The NetMetal is a completely new product in a waterproof enclosure. Its rugged design is made to withstand the toughest conditions, but at the same time is easy to use and can be opened and closed with one hand. The solid aluminium enclosure also works as a reliable heatsink for its high output power radio.

RB922 models have miniPCI-e slot for another wireless card.

Product code	RB921UAGS-5SHPaCt-NM	RB921UAGS-5SHPaCtD-NM	RB922UAGS-5HPaCt-NM	RB922UAGS-5HPaCtD-NM
CPU	QCA9557 720MHz network processor			
Memory	128MB DDR2 onboard memory			
Ethernet	One Gigabit port with Auto-MDI/X			
SFP	1x SFP cage available			
Extras	Beeper, signal and status LEDs, voltage and temperature sensors			
Supported channels	20/40/80MHz			
Expansion	USB 2.0 port		USB 2.0 port, 1x MiniPCIe slot, SIM slot (requires 3g miniPCIe card)	
Power input	PoE in: 8-30V DC on Ether1 (Non 802.3af)			
Consumption	23W	21W	23W	17W
Dimensions	143x247x48mm			
Operating temperature	-40°C .. +70°C tested			
OS	MikroTik RouterOS, Level 4 license, free product lifetime upgrdes			
Kit includes	RB922/R921 outdoor unit, Power adapter 24V 1.2A, PoE injector, miniPCIe mounting screws, DIN rail mount, metal mounting ring, 2x plastic mounting loops			

	RB921UAGS-5SHPaCt-NM	RB921UAGS-5SHPaCtD-NM	RB922UAGS-5HPaCt-NM	RB922UAGS-5HPaCtD-NM
Wireless	QCA9880 5GHz 802.11ac			
Chains	Triple chain	Dual chain	Triple chain	Dual chain
Connector type	RP-SMA Female (outside thread)			
Connectors	3x	2x	3x	2x
TX/RX at MCS0	33dBm / -96dBm	31dBm / -96dBm	32dBm / -96dBm	30dBm / -96dBm
TX/RX at MCS7	31dBm / -77dBm	29dBm / -77dBm	29dBm / -77dBm	27dBm / -77dBm
TX/RX at MCS9	27dBm / -72dBm	25dBm / -72dBm	24dBm / -72dBm	22dBm / -72dBm
TX/RX at 6Mbit	33dBm / -96dBm	31dBm / -96dBm	33dBm / -96dBm	31dBm / -96dBm
TX/RX at 54Mbit	31dBm / -81dBm	29dBm / -81dBm	29dBm / -81dBm	27dBm / -81dBm
Frequency range	4920-6100 MHz, Operating range limited by Country Regulations			



Power adapter

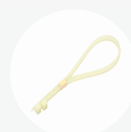

Mounting loops



Metal ring



Gigabit PoE injector



DIN mount



miniPCI screws

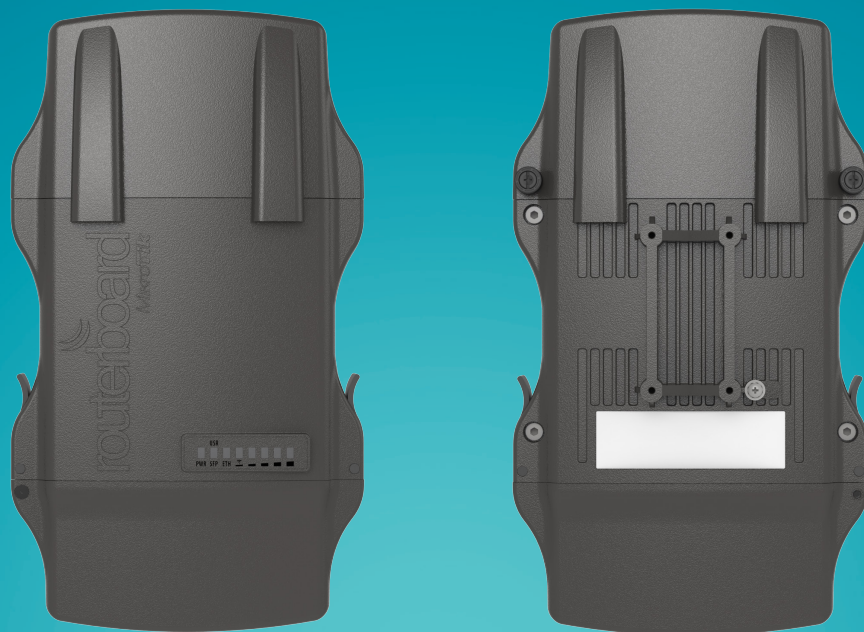

NetBox 5

The NetBox is a dual chain outdoor AP/CPE/Point-to-Point device with RP-SMA connectors for antennas, and a cable hood for protection against moisture. This device supports the new 802.11ac standard for increased wireless speed (866Mbit datarate, and 20/40/80MHz channels).

The case can be opened with one hand, and is protected against the elements. Ethernet and a Grounding wire exits are provided on the bottom, behind a protective door.

Comes with a mounting loop for tower/pole mounting, and a separate DIN rail mount is also provided. Package also includes a PoE injector and power supply unit.

Product code	RB911G-5HPacD
CPU	QCA9557 720MHz network processor
Memory	128MB DDR onboard memory
Ethernet	One Gigabit port with Auto-MDI/X
Wireless	QCA9882 5GHz 802.11ac, 2x RP-SMA connectors, Dual chain
Connector type	RP-SMA Female (outside thread)
Extras	Beeper, signal and status LEDs, voltage and temperature sensors
Supported channels	20/40/80MHz
Power input	PoE in: 8-30V DC on Ether1 (Non 802.3af)
Power consumption	12W at 24V
Operating temperature	-40°C .. +70°C tested
Dimensions	246x135x50mm
OS	MikroTik RouterOS, Level 4 license
Kit includes	Netbox outdoor unit, PoE injector, mounting loop, DIN rail mount, mounting ring, power adapter 24V 0.8A

	TX power / RX sensitivity
TX/RX at MCS0	30dBm / -96dBm
TX/RX at MCS7	27dBm / -77dBm
TX/RX at MCS9	22dBm / -72dBm
TX/RX at 6Mbit	31dBm / -96dBm
TX/RX at 54Mbit	27dBm / -81dBm
Frequency range	4920-6100 MHz, Operating range limited by Country Regulations



Power adapter



Mounting loops



Metal ring



Gigabit PoE injector



DIN mount

Using the optionally available Flexguide cable, you can use the NetBox with any 3rd party antenna

DynaDish 5

The DynaDish 5 is a new Dual Chain 802.11ac outdoor device with an integrated antenna. Compact in its design, it is a simple and completely integrated product. The antenna is a 8 degree 25dBi dish, and it includes a precise alignment mount, ideal for long range point to point wireless links.

- Ideal for long distance point-to-point links
- 5GHz dual chain board integrated into 25dBi dish antenna with 8 degree beam width
- 720Mhz CPU
- One Gigabit Ethernet port



Power adapter



Precision mount



U Kit



Gigabit PoE injector

Model	DynaDish 5
Product code	RBDynaDishG-5HacD
CPU	QCA9557 720MHz CPU
Memory	128MB RAM
Ethernet	One 10/100/1000 Ethernet port
Wireless	Built-in 5 GHz 802.11ac, dual-chain
Antenna	VSRW 1.5; beamwidth h/v: 8°; gain: 25dBi; dual polarization
Port to port isolation	23db
Return loss	< 15db
VSWR	1.5
Extras	Beeper, PCB temperature monitor, voltage monitor
Power consumption	16W
LEDs	14 LEDs (6 user LEDs)
Power input	11V - 60V passive PoE or 802.3af/at with unshielded cable
Dimensions	Ø 404mm, height 175mm (without mount)
Operating temp.	-40°C .. +70°C tested
Operating system	MikroTik RouterOS, Level 3 license
Package contains	DynaDish 5 unit, 24V 0.8A power adapter, precision mount, U kit, Gigabit PoE injector

	Tx (dBm)	Rx (dBm)
6Mbit/s	31	-96
54MBit/s	28	-81
MCS0	30	-96
MCS7	27	-77
MCS9	22	-72

QRT Series

High power integrated antenna

The QRT is a rugged outdoor flat panel antenna, with a built in RouterBOARD. It has high output power wireless transmitter, and a Gigabit Ethernet port.

Easy to use and quick to deploy, QRT is ideal for point to point links.

Three models are available:

- The QRT 5 comes with 5GHz 1000mW wireless and 24dBi antenna
- The QRT 2 comes with 2.4GHz 3200mW wireless and 17dBi antenna
- The QRT 5 ac supports 802.11ac for higher speed and 802.11a/n for backwards compatibility.

Model	QRT 5	QRT 2	QRT 5 ac
Product code	RB911G-5HPnD-QRT	RBQRTG-2SHPnD	RB911G-5HPacD-QRT
Features	1 Ethernet, Gigabit, High power, Dual chain		
CPU	Atheros AR9342 600MHz network processor		QCA9557 720 MHz network processor
Memory	64MB DDR onboard memory		128MB DDR2
Ethernet	One Gigabit port with Auto-MDI/X		
Wireless	Built in 5GHz 802.11a/n (AR9342)	Built in 2GHz 802.11b/g/n (AR9342)	Built in 5GHz 802.11ac (QCA9882)
Extras	beeper, signal and status LEDs, voltage and temperature sensors		
Power input	PoE in: 8-30V DC on Ether1 (Non 802.3af).		
Operating temp.	-40°C .. +70°C tested		
Unit dimensions	309x320x50mm		
Max consumption	11W at 24V	19W at 24V	11.5W at 24V
OS	MikroTik RouterOS, Level 4 license (supports wireless CPE/PtP and AP mode)		
Included	QRT wireless device, precision mounting bracket, U bolts, pole clamp, screw kit, 24V 0.8A power adapter, Gigabit PoE injector		

Model	QRT 5	QRT 2	QRT AC
Frequencies	4.9-5.875 GHz	2.3-2.6 GHz	4.9-5.875 GHz
Gain	24 dBi	17dBi	24 dBi
VSWR	1.37 : 1	1.43 : 1	1.37 : 1
3 dB Beam-Width, H-Plane	10.5°	22°	10.5°
3 dB Beam-Width, E-Plane, typ.	10.5°	22°	10.5°
Polarization	Dual, Vertical and horizontal		
Port to Port Isolation	-50 dB		
Cross polarization, min	-25 dB		
Front to Back Ratio, min	35 dB	30 dB	35 dB

Wireless specifications

	QRT 5	QRT 2	QRT 5 ac
TX/RX at MCS0	30dBm / -96dBm	35dBm / -96dBm	30dBm / -96dBm
TX/RX at MCS7	24dBm / -78dBm	30dBm / -78dBm	24dBm / -78dBm
TX/RX at 6Mbit	30dBm / -96dBm	35dBm / -96dBm	30dBm / -96dBm
TX/RX at 54Mbit	27dBm / -80dBm	31dBm / -80dBm	27dBm / -80dBm
Frequency range	4900-5920MHz	2300-2600MHz	4920-6100 MHz



Precision mounting bracket



U bolts



Pole clamp



Screw kit



Power adapter



Gigabit PoE injector

LHG 5

The Light Head Grid (LHG) is a compact and light wireless device with an integrated 24.5dBi grid antenna at a revolutionary price. It is perfect for point to point links or for use as a CPE at longer distances.

The grid design ensures protection against wind, and the fact that the antenna element is built into the wireless unit means no loss on cables.

The device comes disassembled for compact shipping, but is very easy to assemble and includes a simple to use grounding attachment point. The package also contains a small adapter for tilting the antenna five degrees from the original position.



24V 0.38A Power adapter



K-LHG kit



2x metal rings



PoE injector

Product code	RBLHG-5nD (International) RBLHG-5nD-US (USA)	
CPU nominal frequency	600MHz	
Size of RAM	64MB	
Storage type	Flash	
Storage size	16MB	
10/100 Ethernet ports	1	
Wireless	Built-in 5GHz 802.11a/n, dual-chain	
Wireless chip model	AR9344	
Operating frequency	International	5150 - 5875 MHz
	USA	5170 - 5250 MHz 5725 - 5835 MHz
Antenna gain	24.5 +/- 0.5dBi	
Antenna beam width	7°	
Cross polar	15dBi	
Port to port isolation	20dB	
Front to back ratio	25dB	
Return loss	10dB	
VSWR	1.925:1	
PoE in	Yes	
Supported input voltage	11V - 30V (passive PoE)	
Wind survivability	205 km/h	
Wind loading	186N @ 205km/h	
Operating temperature	-40°C .. +70°C tested	
Operating humidity	5 to 95% noncondensing	
Shock and vibration	ETSI300-019-1.4	
ETSI specification	EN 302 326 DN2	
Dimensions	Ø 391 x 222mm; package 450x450x145mm	
Weight	Unit: 560g; package: 1.98kg	
Max power consumption	6W	

SXT ac series

The new AC standard is here, with up to 866Mbit over the air datarate, 256-QAM modulation, and 80MHz channels. 802.11ac opens up new possibilities and speeds never possible before.

The SXT ac is a new member in our 802.11ac product lineup, currently four models are available — with regular 28 degree antenna (SXT ac), the SA model with a 90 wide beam-width sector antenna, HG model with high gain 17dBi antenna and low-cost Lite model with 10/100Mbps Ethernet port.

All models are backwards compatible with 802.11a/n standard, Nstreme and Nv2 protocols and are compatible with all legacy RouterBOARD devices.

- Up to 1300mW RF output
- Extended temperature range -40°C to +70°C
- Up to 540Mbps user data throughput
- Low latency Point to Point

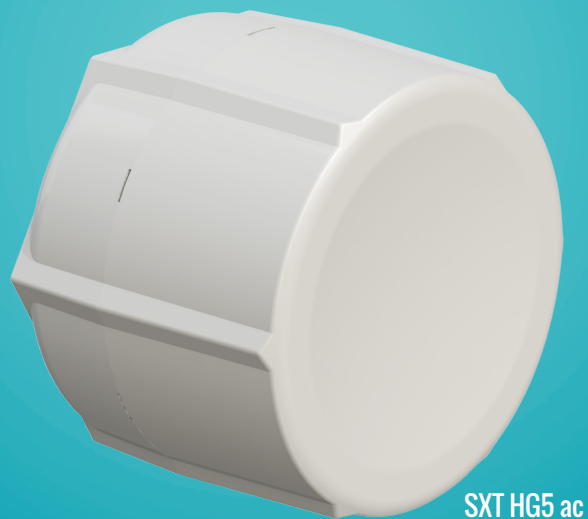
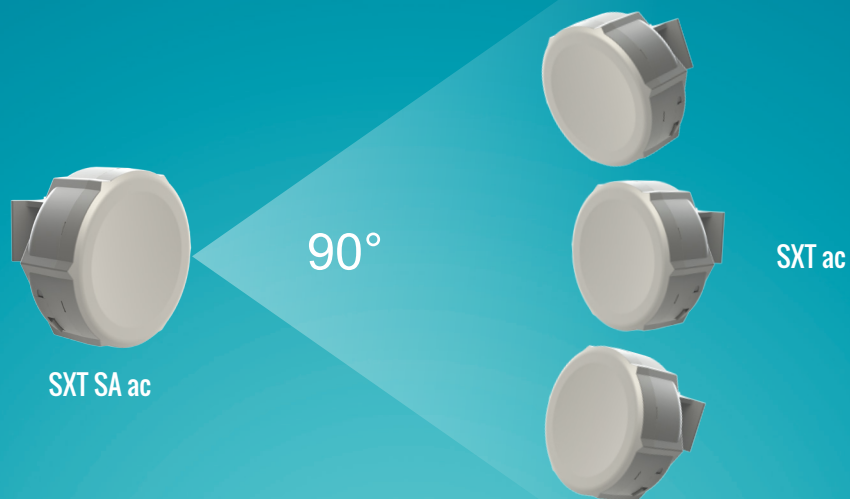

Power adapter



Mounting ring



Pole mounting bracket



PoE injector

Product code	SXT 5 ac	SXT SA5 ac	SXT HG5 ac	SXT Lite5 ac
Model	RBSXTG-5HPacD	RBSXTG-5HPacD-SA	RBSXTG-5HPacD-HG	RBSXT5HacD2n
CPU	QCA9557 720MHz			QCA9531 650 MHz
Memory	128MB DDR2			64MB
Ethernet	1x 10/100/1000 Ethernet			1x 10/100/Ethernet
Wireless	Onboard dual-chain 5GHz 802.11ac; 10kV ESD protection on each RF port			
Supported channels	20/40/80MHz			5*/10*/20/40/80MHz
Supported modes	CPE, Point to Point, Point to Multipoint			CPE, Point to Point
Additional	Reset switch, beeper, USB 2.0 port, voltage and temperature monitors			
LEDs	Power LED, Ethernet LED, 5 wireless signal LED			
PoE in	15-60V DC, Passive and 802.3af/at supported (Mode B. requires crossover cable)			
Dimensions	140x140x56mm		140x140x105mm	140x140x56mm
Max consumption	12W			8W
Operating temp.	-40°C .. +70°C tested			
OS	MikroTik RouterOS, Level 4 license			MikroTik RouterOS, Level 3 license
Package contains	SXT wireless device with integrated antenna, pole mounting bracket, mounting ring, power adapter, passive PoE injector, quick setup guide			
Certifications	FCC, CE, ROHS			

	RBSXTG-5HPacD	RBSXTG-5HPacD-SA	RBSXTG-5HPacD-HG	RBSXT5HacD2n
TX/RX at MCS0	30dBm / -96dBm	30dBm / -96dBm	22dBm / -72dBm	29dBm / -96dBm
TX/RX at MCS7	27dBm / -77dBm	27dBm / -77dBm	30dBm / -96dBm	25dBm / -77dBm
TX/RX at MCS9	22dBm / -72dBm	22dBm / -72dBm	27dBm / -77dBm	22dBm / -72dBm
TX/RX at 6Mbit	31dBm / -96dBm	31dBm / -96dBm	31dBm / -96dBm	29dBm / -96dBm
TX/RX at 54Mbit	28dBm / -81dBm	28dBm / -81dBm	28dBm / -81dBm	26dBm / -81dBm
Antenna	Dual pol. 25deg, 5GHz antenna, 16dBi, -35 dB port to port isolation	Dual pol. 90deg, 5GHz antenna, 13dBi, -35 dB port to port isolation	Dual pol. 24deg, 5GHz antenna, 17dBi gain, -30db port to port isolation	Dual pol. 28deg, 5GHz antenna, 16dBi gain, -30db port to port isolation

*Supports only 802.11an protocol.

SXT 5

SXT is a low cost, high speed 5GHz weatherproof outdoor wireless device. Several models are available.

Complete with a ready to mount enclosure and built-in antenna, SXT contains everything you need to make a point to point link, or connect to an AP.

The Lite5 is low cost and very simple, perfect for CPE installations. SXT 5 has higher power, and the HG model has an improved antenna and a Gigabit port. The SXT SA model offers a completely different, wide beamwidth antenna for use as a sector.

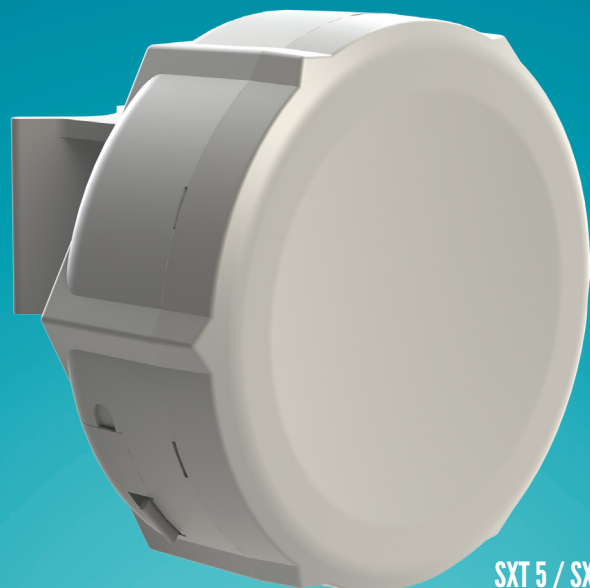

SXT 5 / SXT Lite5 / SXT SA5

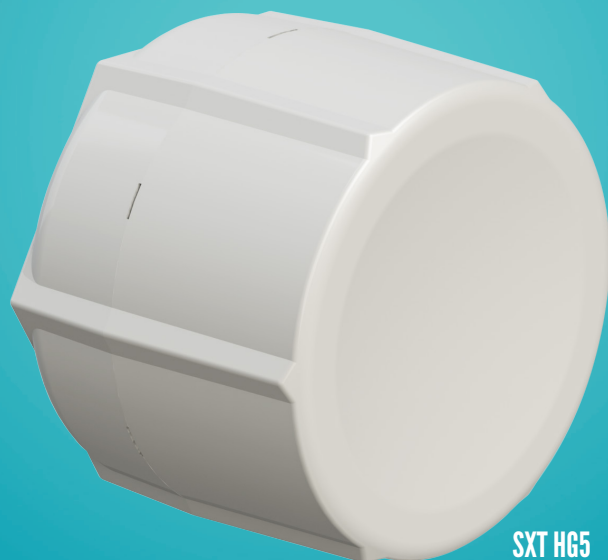

SXT HG5



Power adapter



Mounting ring



Pole mounting bracket



PoE injector

Model	SXT 5	SXT Lite5	SXT HG5	SXT SA5
Product code	RBSXT5HPnDr2	RBSXT5nDr2	RBSXTG-5HPnD-HGr2	RBSXTG-5HPnD-SAr2
CPU	AR9344 600MHz			
Memory	64MB DDR2			
Ethernet	1x 10/100 Ethernet port		1x 10/100/1000 Gigabit Ethernet	
Wireless cards	Onboard dual chain 5GHz 802.11a/n Atheros AR9344 wireless module; 10kV ESD protection on each RF port.			
Frequency range	4920-5920MHz (Limited by country regulatory rules)			
Extras	Reset switch, beeper, USB 2.0 port, voltage and temperature monitors	Reset switch, beeper	Reset switch, beeper, USB 2.0 port, voltage and temperature monitors	
LEDs	Power LED, Ethernet LED, 5 wireless signal LED			
Power input	PoE in: 8-30V DC Packaged with 24V DC 0.8A power adapter and passive PoE injector	PoE in: 8-30V DC Packaged with 24V DC 0.38A power adapter and passive PoE injector	PoE in: 8-30V DC Packaged with 24V DC 0.8A power adapter and passive PoE injector	PoE in: 8-30V DC Packaged with 24V DC 0.8A power adapter and passive PoE injector
Dimensions	140x140x56mm		140x140x105mm	140x140x56mm
Max consumption	11W at 24V	8W at 24V	11W at 24V	11W at 24V
Operating temp.	-40°C .. +70°C tested			
OS	MikroTik RouterOS, Level 3 license		MikroTik RouterOS, Level 4 AP license	
Package contains	SXT wireless device with integrated antenna, pole mounting bracket, mounting ring, PoE injector (SXT 5 and SXT Lite5), Gigabit PoE injector (for HG5 and SA5), power adapter, quick setup guide			
Certifications	FCC, CE, ROHS			

	SXT 5	SXT Lite5	SXT HG5	SXT SA5
TX/RX at MCS0	30dBm / -96dBm	27dBm / -95dBm	30dBm / -93dBm	30dBm / -95dBm
TX/RX at MCS7	26dBm / -77dBm	22dBm / -77dBm	26dBm / -71dBm	26dBm / -73dBm
TX/RX at 6Mbit	30dBm / -96dBm	27dBm / -95dBm	31dBm / -92dBm	30dBm / -96dBm
TX/RX at 54Mbit	27dBm / -81dBm	23dBm / -80dBm	28dBm / -77dBm	27dBm / -80dBm
Antenna	Dual pol. 25deg, 5GHz antenna, 16dBi, -35 dB port to port isolation		Dual pol. 24deg, 5GHz antenna, 16.5dBi, -30 dB port to port isolation, 1.43 VSWR	Dual pol. 90 deg, -35dB port to port isolation, 14dBi gain

SXT 2

SXT is a low cost, high speed 2GHz outdoor wireless device, now also available as a high power Gigabit, or as a low cost Lite version. SXT can be used for point to point links, as a CPE for point to multipoint installations or even as an AP/Sector (SXT 2 model) because of its wide beamwidth antenna.

Complete with a ready to mount enclosure and built-in 10dBi antenna, the package contains everything you need to set it up in a matter of minutes.

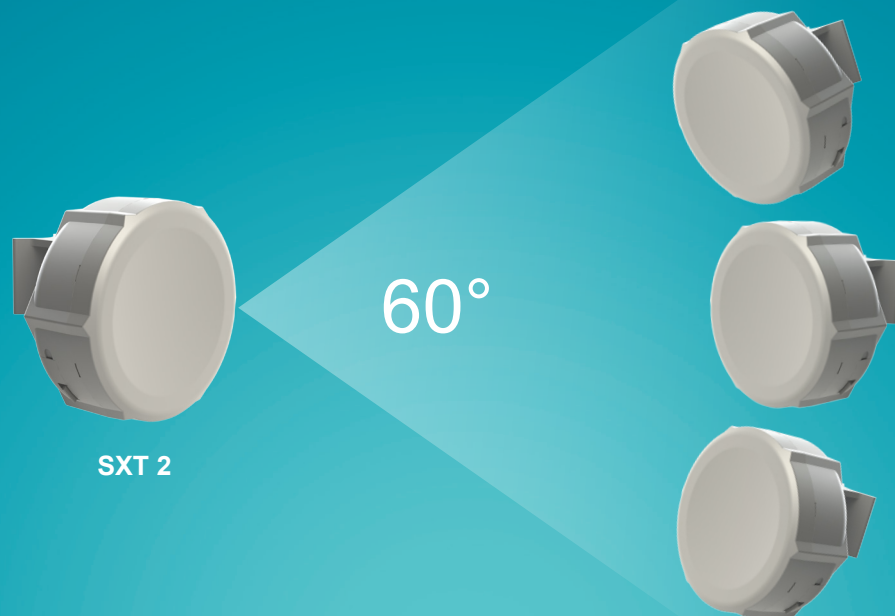

SXT 2

SXT Lite2

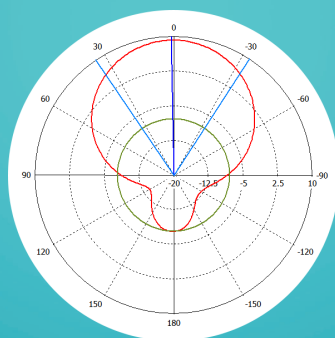

Approximately 60° beamwidth in all polarizations



Power adapter



Mounting ring



Pole mounting bracket



Gigabit PoE injector (SXT 2)



Gigabit PoE injector (SXT Lite2)

Model	SXT 2	SXT Lite2
Product code	RBSXTG2HnD	RBSXT2nDr2
CPU	AR9344 600MHz	
Memory	128MB RAM	64MB RAM
Ethernet	10/100/1000 (Gigabit) Ethernet port L2MTU frame size up to 4076	10/100 Ethernet port
Wireless	Onboard dual chain 2GHz 802.11b/g/n .10kV ESD protection on each RF port	
Extras	Reset switch, beeper, voltage and temperature monitors	Reset switch, beeper
LEDs	Power LED, Ethernet LED, 5 wireless signal LED	
Power input	PoE in: 8-30V DC. Packaged with 24V PSU and passive PoE injector	
Dimensions	140x140x56mm	
Power consumption	Up to 7W	Up to 8W
Operating temp.	-40°C .. +70°C tested	
License	Level 4 license (CPE, PtP or AP as sector)	Level 3 license (CPE or PtP modes)
Package contains	SXT wireless device with integrated antenna, pole mounting bracket, mounting ring, PoE injector, 24V 0.8A power adapter (SXT 2), 24V 0.38A power adapter (SXT Lite2), quick setup guide	
Certifications	FCC, CE, ROHS	

	SXT 2	SXT Lite2
TX/RX at MCS0	32dBm / -95dBm	27dBm / -95dBm
TX/RX at MCS7	25dBm / -74dBm	22dBm / -77dBm
TX/RX at 6Mbit	32dBm / -96dBm	27dBm / -95dBm
TX/RX at 54Mbit	29dBm / -80dBm	23dBm / -80dBm
Antenna	Dual polarization 2GHz antenna, 10dBi, -18 dB port to port isolation, Beam-Width: H-Plane, E-Plane typ. 60°	

SXT LTE

The SXT LTE (product code RBSXTLTE3-7) is a special variant of our popular SXT device, and doesn't include a 802.11 wireless device. Instead, it has a built in high quality LTE Category 3 modem for speeds of up to 100Mbit/s downlink and 50 Mbit/s uplink.

A perfect device for remote locations that are within cellular network coverage. Due to it's professional LTE chip and high gain antenna, it can provide connectivity for your building even where cell phones can't.

The signal LEDs show LTE signal level for easy positioning. The SXT LTE supports the popular LTE/4G FDD bands 3 (1800MHz) and 7 (2600MHz), has a miniSIM slot, doesn't support 2G/3G networks.



24V 0.8A power adapter



Mounting ring



PoE injector

Model	SXT LTE
Product code	RBSXTLTE3-7
CPU	AR7241 400MHz
Memory	64 MB RAM
Storage	128 MB NAND
Ethernet	10/100 Ethernet port
Wireless	3 (1800 MHz) and 7 (2600 MHz) LTE FDD bands, dual chain
Extras	Reset switch, beeper, voltage and temperature monitors, 1x miniSIM (2FF)
Antenna gain	9 dBi
Power input	PoE in: 8-30V DC. Packaged with 24V PSU and PoE injector
Dimensions	140x140x105mm
Power consumption	5W
Operating temp.	-40°C .. +70°C tested
Operating System	RouterOS, Level 3 license

SEXTANT G

Outdoor point to point solution

The SEXTANT is a 18dBi 5GHz antenna with a built in RB911 router. It has two polarizations to give you all benefits of 2x2 MIMO in 802.11n.

Inside is the high power RB911 dual chain wireless device with high performance, high output power wireless transmitter. It has a Gigabit Ethernet port, to fully utilise the benefit of 802.11n high speed wireless.

Easy to use and quick to deploy, SEXTANT is ideal for point to point links.



Frequencies	5.17 - 5.825 GHz
Gain	18dBi
VSWR	1.6:1
3 dB Beam-Width, H-Plane	16.8 °
3 dB Beam-Width, E-Plane, typ.	22.8 °
Polarization	Linear, Vertical and Horizontal
Port to Port Isolation	- 35 dB



Power adapter



Mounting rings



Pole mounting bracket



Gigabit PoE injector

Product code	RBSEXTANTG5HPnD
Features	1 Ethernet, Gigabit, High power, Dual chain
CPU	Atheros AR9342 600MHz network processor
Memory	64MB DDR onboard memory
Data storage	onboard NAND memory chip
Ethernet	One Gigabit port with Auto-MDI/X
Wireless	Built in 5GHz 802.11a/n, 2x MMCX connectors
Extras	beeper, signal and status LEDs, voltage and temperature sensors
Power input	PoE in: 8-30V DC on Ether1 (Non 802.3af).
Operating temp.	-40°C .. +70°C tested
Dimensions	Ø250mm, height 90mm
Max consumption	11W at 24V
OS	MikroTik RouterOS, Level 3 license (supports wireless CPE/PtP mode)
Included	SEXTANT antenna, 24V 0.8A power adapter, mounting rings, pole mounting bracket, Gigabit PoE injector

	TX power / RX sensitivity
TX/RX at MCS0	30dBm / -96dBm
TX/RX at MCS7	24dBm / -78dBm
TX/RX at 6Mbit	30dBm / -96dBm
TX/RX at 54Mbit	27dBm / -80dBm
Frequency range	4900-5920MHz



Metal 5 SHPn



Power adapter



2x Mounting loops



PoE injector



Angled N connector

6dBi omni antenna
(only for 2SHPn model)

2x Metal rings

Metal

Completely waterproof, rugged, and super high powered. The serious outdoor wireless device. Fully sealed, industrial design metal case, powered by RouterBOARD and RouterOS.

It has a built-in N-male connector, and pole attachment points, so you can attach it to an antenna directly, or use a standard antenna cable. LED signal indicators make it easy to install and align.

Shipped complete with power injector, adapter (US type only for 9HPn model) and mounting kit. Available in three versions - 900MHz, 2GHz and 5GHz.

Metal 9HPn is compatible only with another Metal 9HPn. It will not work with any other 900MHz manufacturer product.

Product code	RBMetal9HPn	RBMetal2SHPn	RBMetal5SHPn
CPU	Atheros AR7241 400MHz network processor		
Memory	64MB DDR SDRAM onboard memory		
Ethernet	One 10/100 Mbit/s Fast Ethernet port with Auto-MDI/X, L2MTU up to 2030		
Wireless	Wireless Built-in 900MHz 1x1 MIMO, N-male connector	Wireless Built-in 2 GHz 1x1 MIMO, N-male connector	Wireless Built-in 5 GHz 1x1 MIMO, N-male connector
Extras	Reset switch, Beeper, Voltage monitor, Temperature monitor		
LEDs	5 wireless signal LEDs, ethernet activity LED (configurable)		
Power input	Passive 8-30V PoE in only. 16KV ESD protection on RF port		
Consumption	Up to ~0,5A at 24V (11.5W)		
Dimensions	215x60x38mm. Must be mounted with ethernet pointing down.		
Operating temperature	-40°C .. +70°C tested		
Operating system	MikroTik RouterOS Level 4 license (station, point-to-point or AP modes)		
Package contains	Metal unit, mounting loops, PoE injector, angled N connector, 6dBi omni antenna (only for 2SHPn model), mounting rings, 24V 0.8A power adapter.		

RX sensitivity	5SHPn model	802.11a: -93 dBm @ 6Mbps to -77 dBm @ 54 Mbps 802.11n: -93 dBm @ MCS0 to -71 dBm @ MCS7
	2SHPn model	802.11b/g: -93 dBm @ 6Mbps to -77 dBm @ 54 Mbps 802.11n: -92 dBm @ MCS0 to -72 dBm @ MCS7 40MHz
	9HPn model	900MHz: -93dBm @ 11Mbps -75 dBm @ 54 Mbps
TX power	5SHPn model	802.11a: 31dBm @ 6Mbps to 27dBm @ 54 Mbps 802.11n: 30dBm @ MCS0 to 26dBm @ MCS7
	2SHPn model	802.11b/g: 32dBm @ 1-11/6Mbps to 29dBm @ 54 Mbps 802.11n: 32dBm @ MCS0 to 28dBm @ MCS7
	9HPn model	900Mhz: 27 dBm @ 11Mbps to 24dBm @ 54 Mbps

Metal 52 ac

The Metal is a completely waterproof and rugged outdoor wireless device with a super high output power.

Now with 802.11ac support, a Gigabit Ethernet port and a selectable wireless band (2.4GHz or 5GHz, up to 80 MHz wide channel). The new Gigabit port will help you utilize the full benefit of 802.11ac high speed wireless.

The Metal 52 ac supports 2.4GHz, 5GHz and all the legacy wireless modes as well (802.11 b/g/n for 2.4GHz and 802.11 ac/n/a for 5GHz).

Fully sealed, industrial design metal case, powered by RouterBOARD and RouterOS. With 1300mW of output power - to reach the last mile, in any conditions. The Metal comes with an AP software license, so you can attach your favorite antenna to use it as an AP, to make wireless point-to-point links or as a CPE- whatever you prefer!

The Metal 52 ac includes a Dual Band 2.4/5GHz Omni directional antenna (6dBi 2.4GHz, 8dBi 5GHz), so you can use the unit right out of the box, or use your own antenna.



Power adapter



2x Mounting loops



Gigabit PoE injector



Angled N connector

Dual Band 2.4/5GHz
(6dBi 2.4GHz, 8dBi
5GHz)

2x Metal rings

Product code	RBMetalG-52SHPacn (International) RBMetalG-52SHPacn-US (USA)			
CPU	QCA9556 720MHz			
Size of RAM	64MB			
Memory type	Flash			
Memory size	16MB			
10/100/1000 Ethernet ports	1			
Wireless	5GHz		2.4GHz	
Operating frequency	International	5150 - 5875 MHz	International	2412 - 2484 MHz
	USA	5170 - 5250 MHz 5725 - 5835 MHz	USA	2412 - 2462 MHz
Protocols	802.11a/n/ac		802.11b/g/n	
Chains	Single-chain			
Wireless chip	QCA9889			
PoE in	Yes			
Supported input voltage	10 - 30V			
PCB temperature monitor	Yes			
Voltage monitor	Yes			
Dimensions	215x60x38mm			
Operating temperature	-40°C .. +70°C tested			
License level	4			
Operating System	RouterOS			
Max power consumption	11W			
Weight	Package: 778g; Unit: 300g			

Groove

2GHz / 5GHz outdoor unit



Omni antenna
(Groove A)



Power adapter



Mounting loops



PoE injector

Our smallest outdoor series model - a fully featured wireless RouterBOARD powered by RouterOS. Weatherproof, durable and ready to use. It has one 10/100 Ethernet port with PoE support and a built in wireless radio. It has software selectable 2 or 5GHz wireless mode, and high 500mW output power!

With the Nv2 TDMA technology, up to 125Mbit aggregate throughput is possible! It has a built-in N-male connector, and pole attachment points, so you can attach it to an antenna directly, or use a standard antenna cable. LED signal indicators make it easy to install and align.

CPE or AP versions are available. Groove runs RouterOS with all its features.

CPU	AR9342 600Mhz
Memory	64MB
Ethernet	One 10/100 Mbit/s Fast Ethernet port with Auto-MDI/X, L2MTU up to 2030
Wireless	5 or 2GHz (software selectable) radio, N-male antenna connector
Extras	Reset switch, Beeper, Voltage monitor, Temperature monitor
LEDs	5 wireless signal LEDs, ethernet activity LED (configurable)
Power input	Passive 9-30V PoE in only. 16KV ESD protection on RF port. Up to 0,19A at 24V (4.56W)
Dimensions	177x44x44mm. Must be mounted with ethernet pointing down
Operating temp.	-40°C .. +70°C tested
RouterOS	52HPn: Level 3 license (station or ptp), A-52HPn: Level 4 license (AP, station or ptp)
Package contains	Groove unit, mounting loops, PoE injector, 24V 0.8A power adapter, 2.4/5 GHz Omni antenna (only for Groove A model)

	5GHz	2GHz
RX sensitivity 802.11a	-93 dBm @ 6Mbps to -77 dBm @ 54 Mbps	-93 dBm @ 6Mbps to -77 dBm @ 54 Mbps
RX sensitivity 802.11n	-93 dBm @ MCS0 20MHz to -76 dBm @ MCS7 40MHz	-93 dBm @ MCS0 20MHz to -76 dBm @ MCS7 40MHz
TX power 802.11a	27dBm @ 6Mbps to 22Bm @ 54 Mbps	27dBm @ 6Mbps to 24Bm @ 54 Mbps
TX power 802.11n	26dBm @ MCS0 to 22dBm @ MCS7	27dBm @ MCS0 to 23dBm @ MCS7
Frequency range	4900-5920MHz	2400MHz-2500MHz

Groove 52 ac

2.4GHz / 5GHz outdoor unit

Our smallest outdoor series model - a fully featured wireless RouterBOARD powered by RouterOS.

Weatherproof, durable and ready to use. Now with 802.11ac support, a Gigabit Ethernet port and a selectable wireless band (2.4GHz or 5GHz, up to 80 MHz wide channel). The new Gigabit port will help you utilise the full benefit of 802.11ac high speed wireless.

The Groove A (AP model) comes with Level 4 license and includes a Dual Band 2.4/5GHz Omni directional antenna (6dBi 2.4GHz, 8dBi 5GHz), so you can use the unit right out of the box, or use your own antenna.

The Groove (CPE) model comes with level 3 license for CPE or backbone installations.



Omni antenna
(Groove A)



Power adapter



Mounting loops



Gigabit PoE injector

Product code	RBGrooveGA-52HPacn RBGrooveG-52HPacn
CPU	QCA9556 720MHz
Memory	64MB
Ethernet	One 10/100/1000 Mbit/s Fast Ethernet port with Auto-MDI/X, L2MTU up to 2030
Wireless	5GHz (802.11ac) or 2.4GHz (802.11b/g/n) (software selectable) radio, N-male antenna connector
Extras	Reset switch, Beeper, Voltage monitor, Temperature monitor
LEDs	5 wireless signal LEDs, ethernet activity LED (configurable)
Power input	Passive 11-30V PoE in only. 16KV ESD protection on RF port. Up to 0,19A at 24V (4.56W)
Dimensions	177x44x44mm. Must be mounted with ethernet pointing down
Operating temp.	-40°C .. +70°C tested
RouterOS	Level 4 license (RBGrooveGA version) Level 3 licence (RBGrooveG version)
Package contains	Groove unit, mounting loops, Gigabit PoE injector, 24V 0.38A power adapter, 2.4/5 GHz Omni antenna (only for Groove A model)

Rate (2.4 GHz)	Tx (dBm)	Rx (dBm)
1MBit/s	24	-97
11MBit/s	21	-91
6MBit/s	24	-93
54MBit/s	21	-77
MCS0	24	-93
MCS7	20	-72

Rate (5 GHz)	Tx (dBm)	Rx (dBm)
6MBit/s	26	-93
54MBit/s	21	-78
MCS0	26	-93
MCS7	21	-74
MCS9	19	-69

BaseBox

The BaseBox in an outdoor wireless device, based on our popular RB912 model, fitted with two SMA connectors for antennas, and a cable hood for protection against moisture. Also available are three additional places for antenna connectors, in case you wish to use the BaseBox miniPCIe slot for one more wireless interface to make a dual band device, or a 3G/4G modem.

The case can be opened with one hand, and is protected against the elements. USB, Ethernet and a Grounding wire exits are provided on the bottom, behind a protective door. Two models are available - BaseBox 2 and BaseBox 5 (2 or 5GHz wireless, respectively).

Comes with a mounting loop for tower/pole mounting, and a separate DIN rail mount is also provided. Package also includes a PoE injector and power supply unit.

Model	BaseBox 5	BaseBox 2
Order code	RB912UAG-5HPnD-OUT	RB912UAG-2HPnD-OUT
Features	1 Ethernet, 1 miniPCIe, USB, Additional memory, Gigabit, High power, Dual chain, Outdoor case	
CPU	Atheros AR9342 600MHz network processor	
Memory	64MB DDR onboard memory	
Ethernet	One Gigabit port with Auto-MDI/X	
Wireless	Built in 5GHz 802.11a/n, 2x RP-SMA connectors	Built in 2GHz 802.11b/g/n, 2x RP-SMA connectors
Connector type	RP-SMA Female (outside thread)	
Extras	beeper, signal and status LEDs, SIM slot (requires 3g miniPCIe card), voltage and temperature sensors	
Expansion	miniPCIe slot for 802.11 or 3G (using 3G disables the USB port), USB 2.0 port	
Power input	PoE in: 8-30V DC on Ether1 (Non 802.3af). Consumption: 14W at 24V	
Operating temp.	-40°C .. +70°C tested	
Dimensions	246x135x50mm	
OS	MikroTik RouterOS, Level 4 license (supports wireless AP mode)	
Kit includes	RB912 outdoor unit, 24V 0.8A power adapter, PoE injector, mounting loop, DIN rail mount, mounting ring	

	RB912UAG-5HPnD-OUT	RB912UAG-2HPnD-OUT
TX/RX at MCS0	30dBm / -96dBm	30dBm / -96dBm
TX/RX at MCS7	24dBm / -78dBm	24dBm / -78dBm
TX/RX at 6Mbit	30dBm / -96dBm	30dBm / -96dBm
TX/RX at 54Mbit	27dBm / -80dBm	27dBm / -80dBm
Frequency range	4900-5920MHz	2400MHz-2500MHz

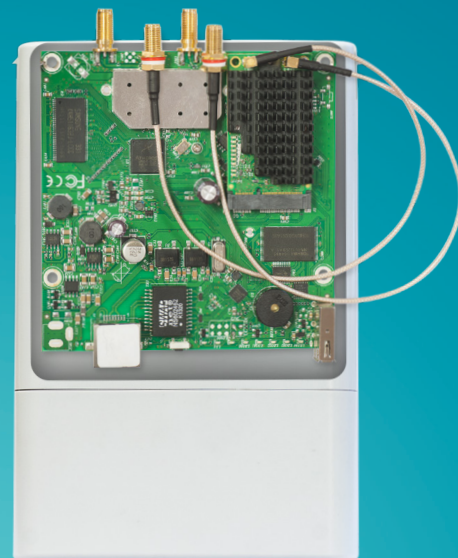

Rendered image shows internals of BaseBox with optional second wireless card

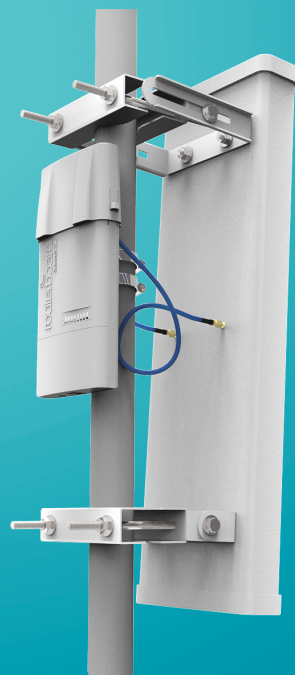

Using the optionally available Flexguide cable, you can use the Basebox with any 3rd party antenna



Power adapter

Mounting loops

Metal ring



Gigabit PoE injector

DIN mount

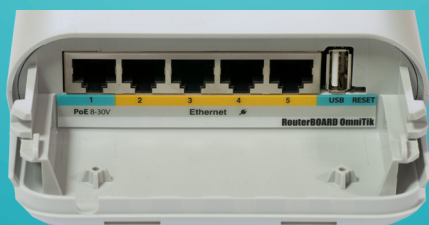

Power adapter



Mounting bracket



Metal ring



PoE injector

OmniTik

OmniTik is a weatherproof outdoor AP with dual-polarized omni antennas - the perfect companion for our SXT, or for any other 5GHz 802.11a/n standard device. Weatherproof, durable and ready to use. It has five 10/100 Ethernet ports, PoE support and a built-in 400mW 802.11a/n wireless radio. It supports Nv2 TDMA technology with up to 200Mbit aggregate throughput.

LED signal indicators on it's back are fully customizable, show Ethernet activity or wireless signal - or any other information from RouterOS. The USB port gives the ability to connect a 3G modem or a storage drive.

The OmniTik UPA also features power output on it's ethernet ports. Ports 2-5 can power other PoE capable devices with the same voltage as applied to the unit. Less power adapters to worry about.

Model	OmniTik U-5HnD	OmniTik UPA-5HnD
CPU	Atheros AR9344 600MHz network processor	
Memory	64MB DDR2 onboard memory	128MB DDR2 onboard memory
Ethernet	Five 10/100 Mbit/s Fast Ethernet port with Auto-MDI/X, L2MTU up to 2030	
Wireless	Wireless Built-in 5GHz 802.11a/n 2x2 MIMO	
Antenna	Two 7.5dBi (+/-1dBi) omni with different polarities (ch0 horizontal, ch1 vertical)	
Extras	Reset switch, Beeper, USB 2.0 port, Voltage monitor, Temperature monitor	
LEDs	5 programmable LEDs (Ethernetactivity by default), one power LED	
Power input	Passive 11-30V PoE in only. 16KV ESD protection on RF port	
Dimensions	177x44x44mm	
Operating temp.	-40°C .. +70°C tested	
Operating system	MikroTik RouterOS, Level 4 license	MikroTik RouterOS, Level 5 license
Package contains	OmniTik unit, mounting bracket, hose clamp, PoE injector, 24V 0.8A PSU (U-5HnD), 24V 2.5A PSU (UPA-5HnD),	
	OmniTik UPA-5HnD	
Power Output	Supports PoE output on ports 2-5. Max current 1A per port, 2A total	

RX sensitivity	802.11a: -96 dBm @ 6Mbps to -78 dBm @ 54 Mbps 802.11n: -96 dBm @ MCS0 to -75 dBm @ MCS7
TX power	802.11a: 30dBm @ 6Mbps to 27dBm @ 54 Mbps 802.11n: 30dBm @ MCS0 to 26dBm @ MCS7
Modulations	OFDM: BPSK, QPSK, 16 QAM, 64QAM DSSS: DBPSK, DQPSK, CCK

Cloud Router Switch

CRS 8 Ethernet port series

The CRS series combine the best features of a fully functional router and a Layer 3 switch, is powered by the familiar RouterOS. All the specific Switch configuration options are available in a special Switch menu, but if you want, ports can be removed from the switch configuration, and used for routing purposes.

These 8 Ethernet port devices share the same form factor, but each comes with slightly different port set and features.



CRS109-8G-1S-2HnD-IN

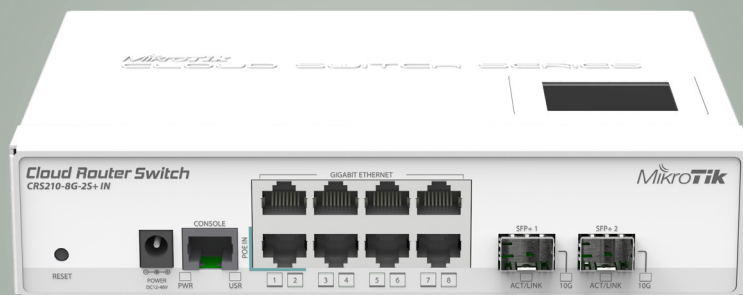

CRS210-8G-2S+IN



CRS112-8G-4S-IN



Power adapter



microUSB cable



Rackmount ears

Product code	CRS109-8G-1S-2HnD-IN	CRS210-8G-2S+IN	CRS112-8G-4S-IN
CPU	Qualcomm Atheros AR9344 600MHz	QCA8519-AC2C 400 MHz	QCA8511-AL1C 400 MHz
Memory	128MB	64MB	128MB
Ethernet	8x 10/100/1000 Mbit/s Gigabit Ethernet with Auto-MDI/X		
SFP	One 1G Ethernet SFP cage, DDMI support.	2x 10G SFP+ cage, DDMI support.	4x 1G Ethernet SFP cage, DDMI support.
Serial port	One RJ45 serial port		
Extras	Reset switch; beeper; voltage and temperature monitoring, touchscreen LCD, microUSB	Reset switch; beeper; voltage and temperature monitoring, touchscreen LCD	Reset switch; voltage and temperature monitoring
Power input	10-57V, 24V 0.8A PSU included, PoE in: 10-57V on Ether1		
Power consumption	13W		
Case dimensions	200x144x47mm		
Operating temp.	-20°C .. +70°C tested		
Antennas	2x built in 4dBi swivel antennas	-	
OS	MikroTik RouterOS v6, Level 5 license		
Included	CRS switch, 24V 0.8A power adapter, microUSB type B to USB type A adapter	CRS switch, 24V 0.8A power adapter, rackmount ears	CRS switch, 24V 0.8A power adapter

CRS109-8G-1S-2HnD-IN wireless specifications

Datarate	TX power dBm	RX sensitivity
1MBit/s	29	-97
11MBit/s	28	-90
6MBit/s	30	-96
54MBit/s	25	-76
MCS0	30	-96
MCS7	23	-73

Cloud Router Switch

CRS 24 port series

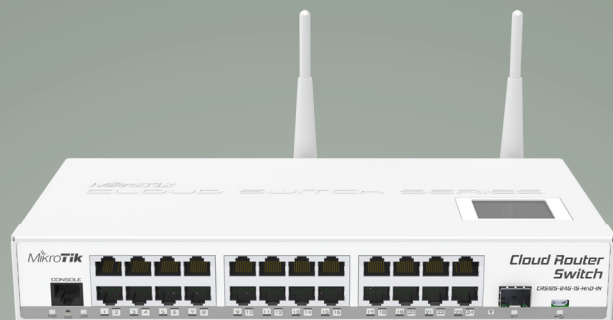

CRS125-24G-1S-2HnD-IN



CRS125-24G-1S-IN



CRS125-24G-1S-RM



CRS226-24G-2S+RM



Power adapter



USB cable

Cloud Router Switch is our new Smart Switch series. It combines the best features of a fully functional router and a Layer 3 switch, is powered by the familiar RouterOS. All the specific Switch configuration options are available in a special Switch menu, but if you want, ports can be removed from the switch configuration, and used for routing purposes.

Four models are available:

- RM models come with 1U rackmount case
- IN with desktop case
- 2HnD have a 2.4GHz Dual-chain wireless
- 226 series supports SFP+ 10G.

Model	CRS125-24G-1S		CRS226-24G-2S+
Case type	IN, RM	2HnD-IN	RM
CPU	Qualcomm Atheros AR9344 600 MHz		Qualcomm Atheros QCA8519 400 MHz
Memory	128MB		64MB
Ethernet	24x 10/100/1000 Mbit/s Gigabit Ethernet with Auto-MDI/X		
Wireless AP	-	802.11b/g/n built in	-
SFP	One 1.25G Ethernet SFP cage (Mini-GBIC; SFP module not included), DDMI support		First port supports 1.25G/10G modules, second port only 10G modules. SFP+ port supports only modules up to 10KM LR (long reach), DDMI support
Expansion	microUSB port		-
Storage	128MB Onboard NAND with multiple OS partition support		
Serial port	One RJ45 serial port		
Extras	Reset switch, beeper, voltage and temperature monitoring, touchscreen LCD		
Power input	8-28V, 24V 0.8A PSU included, PoE in: 8-30V on Ether1	8-28V, 24V 1.2A PSU included, PoE in: 8-30V on Ether1	
Case dimensions	285x145x45mm (IN models), 443x145x45mm (RM models)		
Operating temp.	-20°C .. +70°C tested		
OS	MikroTik RouterOS v6, Level 5 license		
Included	CRS switch, power adapter and USB OTG cable (for 4G dongle or USB drive)		CRS switch, power adapter

CRS125-24G-1S-2HnD-IN wireless specifications

Antennas	2x built in 4dBi swivel antennas
RX sensitivity	802.11g: -96dBm @ 6Mbit/s to -80dBm @ 54Mbit/s 802.11n: -96dBm @ MCS0 to -78dBm @ MCS7
TX power	802.11g: 30dBm @ 6Mbps to 25dBm @ 54 Mbps 802.11n: 30dBm @ MCS0 to 23dBm @ MCS7
Modulations	OFDM: BPSK, QPSK, 16 QAM, 64QAM DSSS: DBPSK, DQPSK, CCK

Cloud Router Switch

CRS212-1G-10S-1S+IN

Cloud Router Switch 212-1G-10S-1S+IN is new “small size low cost” member of our CRS series. It comes with one Gigabit Ethernet RJ45 port, ten SFP cages and one 10G SFP+ cage, as well as LCD panel and serial port (RJ45). Product includes indoor desktop case and power supply.

Our CRS series combines the best features of a fully functional router and a Layer 3 switch, is powered by the familiar RouterOS. All the specific Switch configuration options are available in a special Switch menu, but if you want, ports can be removed from the switch configuration, and used for routing purposes.

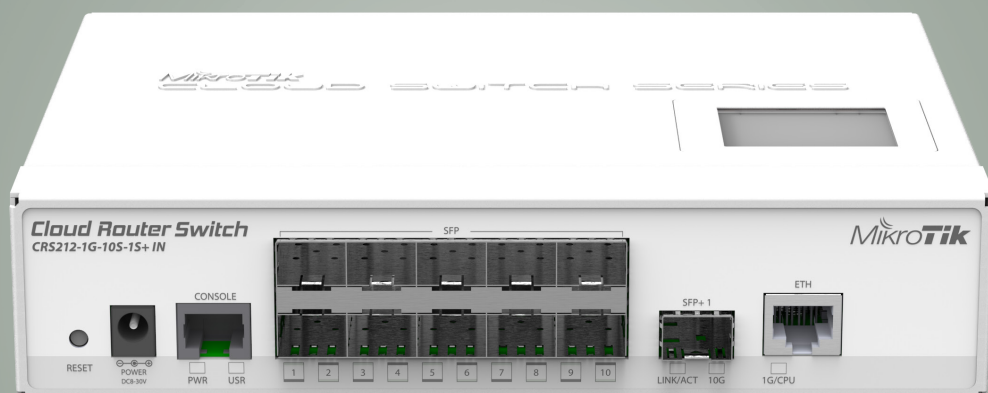

CPU	Qualcomm Atheros 8519 400MHz
Memory	DDR2 64MB
Ethernet	1x 10/100/1000 Mbit/s Gigabit Ethernet with Auto-MDI/X
SFP	1x 10G SFP+ cage, 10x SFP cages (Mini-GBIC; SFP+ module not included), DDMI support.
Storage	128MB Onboard NAND with multiple OS partition support
Serial port	One RJ45 serial port
Extras	Reset switch; beeper; voltage and temperature monitoring, touchscreen LCD
Power input	8-30V, 24V 1.2A PSU included
Power consumption	20W
Operating temp.	-20°C .. +70°C tested
Case dimensions	200x144x47mm
OS	MikroTik RouterOS v6, Level 5 license
Included	CRS switch, 24V 1.2A power adapter, rackmount ears



Power adapter



Rackmount ears

RB260GS series

The RB260GS is a small SOHO switch. Two models are available, the RB260GS, and the RB260GSP, which features power output on its ethernet ports. Ports 2-5 can power other PoE capable devices with the same voltage as applied to the unit.

Both devices have five Gigabit Ethernet ports and one SFP cage, switching is done by an Atheros Switch Chip.

The devices are running an operating system designed specifically for MikroTik Switch products - SwOS.

SwOS is configurable from your web browser. It gives you all the basic functionality for a managed switch, plus more: Allows to manage port-to-port forwarding, apply MAC filter, configure VLANs, mirror traffic, apply bandwidth limitation and even adjust some MAC and IP header fields.

Tested and recommended to use with MikroTik SFP modules: S-85DLC05D, S-31DLC20D and S-35/53LC20D (not included)



Power adapter

CPU	Taifatech TF470
Memory	Embedded 96K SRAM
Ethernet	Five 10/100/1000 Ethernet ports, Atheros switch AR8327
PoE output	RB260GSP only: Passive PoE output on ports 2-5. Max current 1A per port, 2A total current limit
SFP	One fixed Gigabit Ethernet SFP cage with DDMI support (Mini-GBIC; SFP module not included)
Serial port	No serial port
LEDs	Power, NAND activity, 5 Ethernet activity LEDs
Extras	Hardware watchdog
Power input	PoE in: 8-30V DC on Ether1 (Non 802.3af). Jack: 8-30V DC
Dimensions	113x138x29mm
Power consumption	Up to 6W
Operating temperature	-20°C .. +70°C tested
Operating System	MikroTik SwOS
Included	RB switch, power adapter

hEX

The hEX is a small five port ethernet router in a nice plastic case. Not only this is an attractive looking tiny SOHO unit, its price is lower than the RouterOS license alone - there simply is no choice when it comes to managing your wired home network, the hEX has it all.

You have a choice between the hEX lite with 10/100Mbit ports, the hEX PoE lite with PoE-out and hEX, which has Gigabit Ethernet ports.

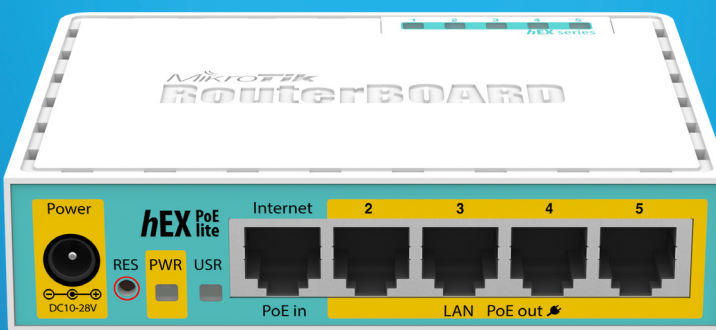
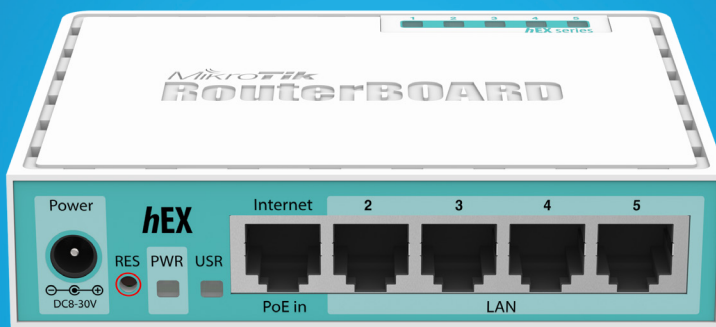
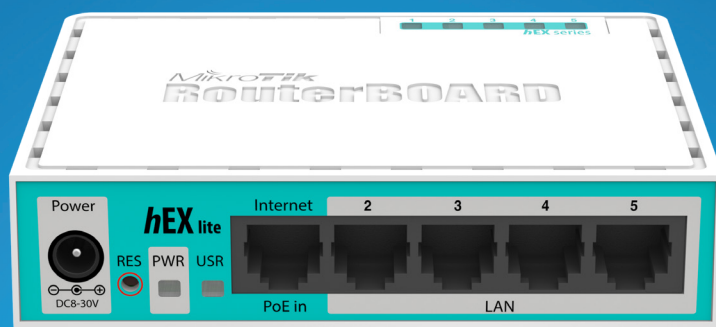

Power adapter

Model	hEX	hEX lite	hEX PoE lite
Product code	RB750Gr2	RB750r2	RB750UPr2
CPU	QCA9556 720MHz CPU	QCA9531 850MHz CPU	QCA9531 650 MHz CPU
RAM	64MB		
Data storage	16MB flash		
Ethernet	5x 10/100/1000 Ethernet ports with Auto-MDI/X	5x 10/100 Ethernet ports with Auto-MDI/X	
LEDs	Power, user, 5 Ethernet LEDs		
Power input	PoE in: 6V-30V DC on Ether1; Jack: 6V-30V DC		
Power output	-		On ports 2-5, Output: 1A max per port; 2A max total
Operating temp.	-20°C .. +70°C tested		
Dimensions	113x89x28mm		
Power consumption	4W	2W	3W
Operating System	MikroTik RouterOS, Level 4 license		
Package contains	RouterBOARD in a plastic case, 12V 0.5A power adapter	RouterBOARD in a plastic case, 12V 1A power adapter	RouterBOARD in a plastic case, 24V 2.5A power adapter

PowerBOX

The PowerBOX is an outdoor five Ethernet port router with PoE output on four ports. You can use this device to supply power to four PoE capable devices such as our SXT or others. Since the device has a waterproof outdoor case, you can mount it on a tower, or in other outdoor locations.

The unit has five shielded Ethernet ports, four of which can power other PoE capable devices with the same voltage as applied to the unit (max current out is 1A per port, max total out is 2A).

Less power adapters and cables to worry about!



IEC cord



Metal ring



Mounting loop



POE injector



Power adapter



DIN mount

Product code	RB750P-PBr2
CPU	QCA9531 650MHz CPU
Memory	64MB 200MHz DDR RAM, 64MB Flash
Ethernet	5x 10/100 Mbit/s Ethernet with Auto-MDI/X
Extras	Reset switch, voltage and temperature monitors
LEDs	11x LED (5x user LEDs)
Power input	PoE in: 5-30V; packaged with 24V DC 2.5A power adapter
Dimensions	125x178x48mm
Max consumption	3W at 24V
Operating temp.	-40°C .. +60°C tested
OS	MikroTik RouterOS, Level 4 license

RB2011 Series

RB2011 are multifunctional routers with 5 Gigabit Ethernet ports and 5 Fast Ethernet ports, and multiple models available. The RB2011iL are lower cost, but the RB2011Ui series have full features.

All RB2011 devices are powered by a new generation Atheros 600MHz 74K MIPS CPU.



RB2011iLS-IN



RB2011iL-IN



RB2011UiAS-IN



RB2011iL-RM



RB2011UiAS-RM



Power adapter

Model	RB2011iL	RB2011UiAS
CPU	Atheros AR9344 600MHz	
Memory	64MB DDR SDRAM onboard memory	128MB DDR SDRAM onboard memory
Ethernet	Five 10/100 Mbit Fast Ethernet ports with Auto-MDI/X Five 10/100/1000 Mbit Gigabit Ethernet ports with Auto-MDI/X	
Extras	Reset button, Reset jumper	
LEDs	Power, User, Ethernet activity	
Power input	Jack 8-28V DC; PoE in: 8-28V DC on Ether1 (Non 802.3af).	
Power output	500mA on Port 10	
Operating temperature	-20°C .. +70°C tested	
Dimensions	Desktop:230x90x25mm Rackmount:443x92x44mm	
Power consumption	8W max	15W max
Operating System	MikroTik RouterOS, Level 4 license	MikroTik RouterOS, Level 5 license
Package includes	RB2011, 24V 0.8A power supply	

Feature / Model	2011iL-IN	2011iL-RM	2011iLS-IN	2011UiAS-IN	2011UiAS-RM
Enclosure	Desktop	Rackmount	Desktop	Desktop	Rackmount
SFP port	-	-	Yes	Yes	Yes
USB	-	-	-	Yes	Yes

RB3011 Series

The RB3011 is a new multi port device, our first to be running an ARM architecture CPU for higher performance than ever before. The RB3011 has ten Gigabit ports divided in two switch groups, an SFP cage and for the first time a super speed USB 3.0 port, for adding storage or an external 3G/4G modem.

The RB3011UiAS-2HnD-IN also has 2.4Ghz wireless AP functionality.

In addition, both units feature a touchscreen LCD panel, a serial console port, and PoE output functionality on the last Ethernet port.

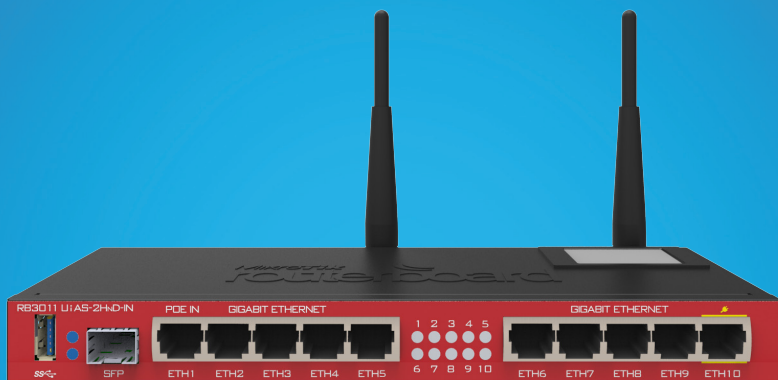

RB3011UiAS-2HnD-IN



RB3011UiAS-RM



Power adapter

Product code	RB3011UiAS-2HnD-IN	RB3011UiAS-RM
CPU	Two core IPQ8064 1.4 GHz CPU	
Memory	1GB DDR3 RAM	
Ethernet	Ten 10/100/1000 Mbit Gigabit Ethernet ports with Auto-MDI/X	
Extras	One USB 3.0 type A slot, Reset button, Reset jumper	
LEDs	Power, User, Ethernet activity	
Power input	Jack 10-30V DC; PoE in: 10-30V DC on Ether1	
Power output	1A on Port 10	
Operating temperature	-20°C .. +70°C tested	
Dimensions	230x90x25mm	443x92x44mm
Serial port	RJ45	
Power consumption	16W	10W
Enclosure	Desktop	Rackmount
SFP port	One SFP cage	
USB port	One USB 3.0 type A	
Operating System	MikroTik RouterOS, Level 5 license	
Package includes	RB3011, 24V 1.2A power adapter	

RB1100AHx2

This device is a high performance 1U rackmount Gigabit Ethernet router. It has thirteen individual gigabit Ethernet ports, two 5-port switch groups, and includes Ethernet bypass capability.

RB1100AHx2 has a dual core 1066MHz CPU with hardware accelerated IPsec encryption, a SODIMM slot for RAM, one microSD card slot, a beeper and a serial port.

It comes preinstalled in a 1U aluminium rackmount case, assembled and ready to deploy.

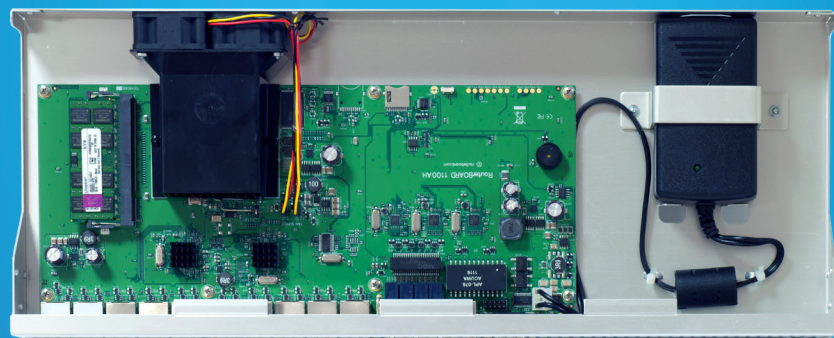

CPU	PowerPC 1066MHz Dual Core with hardware encryption
Memory	SODIMM DDR Slot; 2GB installed
Boot loader	RouterBOOT, 1Mbit Flash chip
Data storage	Onboard NAND memory chip
Ethernet	Thirteen 10/100/1000 Mbit/s Gigabit Ethernet with Auto-MDI/X Includes switch to enable Ethernet bypass mode in two ports
Storage	Onboard NAND, one microSD slot
Serial port	One DB9 RS232C asynchronous serial port
Extras	Reset switch, beeper, voltage and temperature sensors
Power input	IEC C14 standard connector 110/220V
Operating temp.	-20°C .. +70°C tested
Fan	Dual fan with failover support mounted at case back
Dimensions	1U case: 44x176x442mm
Operating System	MikroTik RouterOS, Level 6 license
Included	RB router, IEC cord, rackmount ears (aluminum), screw and feet kit (K10)



IEC cord



Rackmount ears



Screw and feet kit

Cloud Core Router

CCR1009 series

The CCR1009 is a powerful Ethernet router based on the cutting edge TILERA 9 core CPU that comes with eight Gigabit Ethernet ports and one SFP cage. Three models are available.

CCR1009-8G-1S-PC comes with 1GB of RAM and passive cooling enclosure. It's equipped with two heat-pipes and a specially designed heat-sink, so its completely silent.

CCR1009-8G-1S-1S+PC also comes with passive cooling enclosure, additionally it has 2GB of RAM and one SFP+ cage for 10G connections.

CCR1009-8G-1S-1S+ has the 2GB of RAM, one SFP+ cage for 10G connections, 1U rackmount case and dual power supplies built in for redundancy (if one power line fails, the other one will take over automatically).

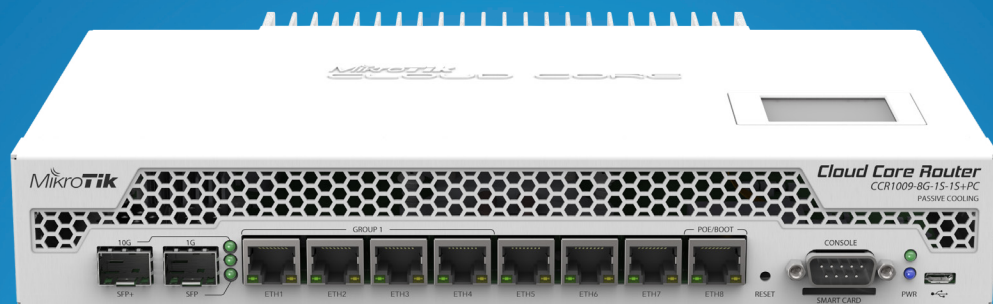

CCR1009-8G-1S-1S+PC

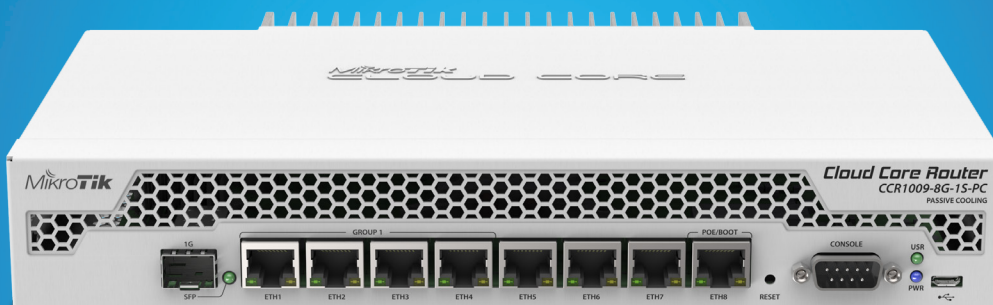

CCR1009-8G-1S-PC



CCR1009-8G-1S-1S+



IEC cord



USB cable

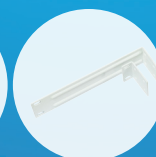

Rackmount ears (PC)



Power adapter



Rackmount ears (RM)

Product code	CCR1009-8G-1S-1S+PC	CCR1009-8G-1S-PC	CCR1009-8G-1S-1S+
CPU	TILE-Gx8009		
Cores	9x cores, 1Ghz per core		9x cores, 1.2Ghz per core
Memory	Built in 2GB RAM 533 Mhz	Built in 1GB RAM 800 Mhz	Built in 2GB RAM 800 MHz
Ethernet	8x 10/100/1000 Mbit/s Gigabit Ethernet with Auto-MDI/X		
SFP	1x SFP cage, 1x SFP+ cage, DDMI support	1x SFP cage, DDMI support	1x SFP cage, 1x SFP+ cage. SFP+ port supports only modules up to 10KM LR (long reach)
Expansion	microUSB port, SmartCard slot, MicroSD slot	microUSB port	microUSB port, SmartCard slot, MicroSD slot
Storage	128MB Onboard NAND		
Serial port	One DB9 RS232C asynchronous serial port		
LCD	Yes	No	Yes
Extras	Reset switch; beeper; voltage, current and temperature monitoring		Reset switch; beeper; voltage, current and temperature monitoring, speed controlled fan
Power options	External 18-58V PSU included, Passive PoE input 18-58V		2x IEC C14 power jacks AC 110/220V, PoE in 12-58V, 802.3af/at compliant
Operating temp.	-20°C .. +70°C tested		
Max power consumption	30W		35W
Board dimensions	272x190x47mm		444x175x47mm
OS	MikroTik RouterOS v6, Level 6 license		

Cloud Core Router

CCR1016 Series

CCR1016 is an industrial grade router with a cutting edge 16 core Tiler CPU. If you need many millions of packets per second - Cloud Core Router is your best choice.

Two models are available. **CCR1016-12G** has twelve Gigabit ethernet ports, a serial console cable and a USB port.

CCR1016-12S-1S+ has twelve SFP ports and one SFP+ port for 10G connectivity. It is available in a 1U rackmount case and also has a serial console port, a touchscreen LCD and a USB port.



CCR1016-12G



CCR1016-12S-1S+

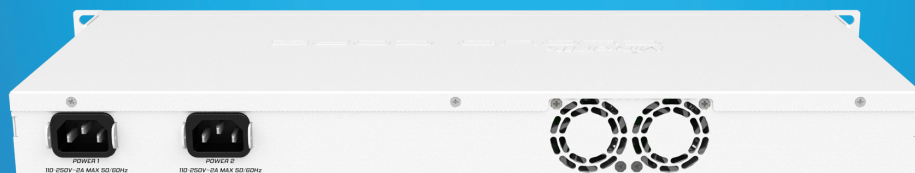

IEC cord



RJ45 SFP copper module



Rackmount ears



USB cable

Model	CCR1016-12G	CCR1016-12S-1S+
CPU	Tiler Tile-Gx16 CPU (16-cores, 1.2Ghz per core)	
Memory	Two SODIMM DDR3 slots, 2x 1GB installed (no hw or software max limit)	2GB built-in RAM
Ethernet	Twelve 10/100/1000 Mbit/s Gigabit Ethernet with Auto-MDI/X	-
SFP	-	Twelve SFP ports and one SFP+ port
Expansion	microUSB port	
Storage	512MB Onboard NAND	128MB Onboard NAND
Serial port	One DB9 RS232C asynchronous serial port	
Extras	Reset switch; beeper; voltage, current and temperature monitoring; speed controlled fan	
Power input	1x PSU unit built in, 110/220V. IEC C14 standard connector	2x PSU units built in, 110/220V. IEC C14 standard connectors
Dimensions	442x185x45mm	442x195x45mm
Operating temp.	Max ambient temperature 60°C @ 1.2GHz	Max ambient temperature 60°C @ 1.2GHz
OS	MikroTik RouterOS v6, Level 6 license	
Included	router in a 1U case, IEC power cable, usb cable	router in a 1U case, IEC power cable, RJ45 SFP 10/100/1000M copper module

Cloud Core Router

CCR1036 Series

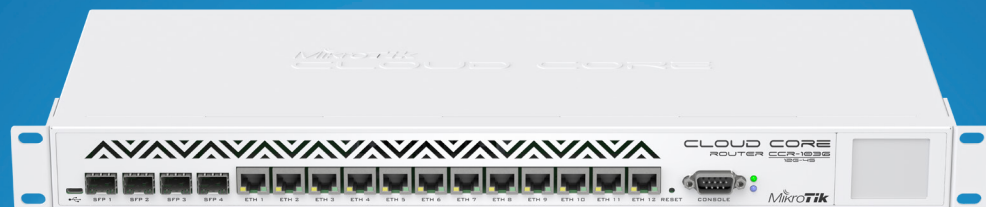

CCR1036-12G-4S



CCR1036-8G-2S+

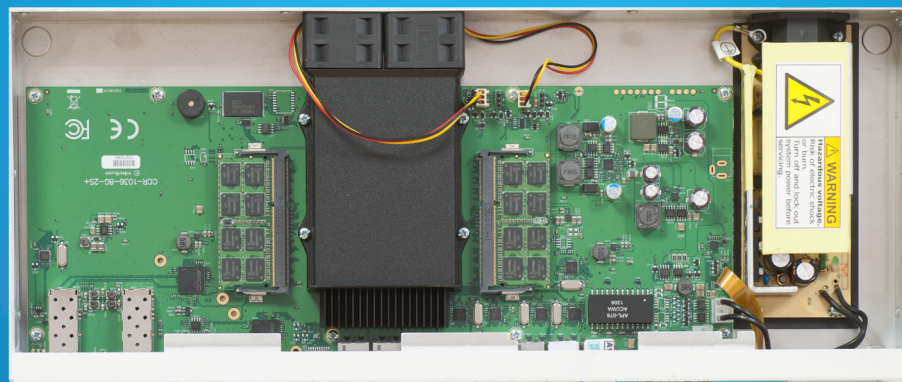

IEC cord



Rackmount ears



USB cable

Cloud Core Router is an industrial grade Ethernet router with a cutting edge 36 core TILERA CPU. These are our top of the line routers and can deliver up to 42 million packets per second, or 28 Gigabits throughput (CCR1036-8G model).

Two models are available, the CCR1036-12G-4S has 12 Gigabit ports and 4 SFP ports. The CCR1036-8G-2S+ has 8 Gigabit ports, and two SFP+ ports for 10G connectivity. Both of the units are also available with 16GB of RAM (-EM upgrade).

Model	CCR1036-12G-4S	CCR1036-8G-2S+
CPU	Tilera Tile-Gx36 CPU (36-cores, 1.2Ghz per core)	
Memory	Two SODIMM DDR3 slots, 2x2GB installed (no hw or software max limit) "-EM" models: 2x8GB RAM installed	
Ethernet	Twelve 10/100/1000 Mbit/s Gigabit Ethernet with Auto-MDI/X	Eight 10/100/1000 Mbit/s Gigabit Ethernet with Auto-MDI/X
SFP	Four 1.25G Ethernet SFP cage (Mini-GBIC; SFP module not included), DDMI support	Two 10G Ethernet SFP+ cages (Mini-GBIC; SFP module not included), DDMI support. SFP+ port supports only modules up to 10KM LR (long reach).
Expansion	microUSB port	
Storage	1GB Onboard NAND	
Serial port	One DB9 RS232C asynchronous serial port	
Extras	Reset switch; speed controlled fan; beeper; voltage, current and temperature monitoring	
Power input	IEC C14 standard connector 110/220V (PSU included), up to 60W power consumption	
Board dimensions	355x145mm55mm	
Operating temp.	Max ambient temperature 60°C @ 1.2GHz	
OS	MikroTik RouterOS v6, Level 6 license	
Included	Router in a 1U case, power cable, usb cable, rackmount ears	

Cloud Core Router

CCR1072-1G-8S+

Our new flagship router, the CCR1072, is powered by a Tileria 72 core CPU, each core is clocked at 1GHz, and to fully utilise this power, the CCR1072 is equipped with eight independently connected 10G SFP+ ports.

Thanks to the unique 72 core processor and ports that are directly connected to the CPU, CCR1072 is capable of over 120 million packets per second throughput.

The unit comes equipped with two removable (hot plug) power supplies for redundancy, smart card slot, eight SFP+ ports and 16GB of built in ECC RAM.

The CCR1072 also has two built-in M.2 slots, microSD and 2x USB for adding storage, to use for proxy cache, user manager and other features. The M.2 slots accept 800mm Key-M x4 PCIe 2.0 modules.



2x IEC cords



Screw and feet kit



Rackmount ears

Full set of features

- 8x SFP+ ports
- 16GB ECC RAM
- Ports directly connected to CPU
- microSD and 2x M.2

Highest performance

- over 120 million pps packet throughput
- up to 80 Gbps throughput

New generation CPU

- 72 core CPU
- 1 GHz clock per core
- State of the art TILE G architecture

CPU	Tilera Tile-Gx72 CPU (72-cores, 1Ghz per core)
Memory	Built in 16GB ECC RAM
Ethernet	One 10/100/1000 Mbit/s Gigabit Ethernet with Auto-MDI/X
SFP	Eight 10G Ethernet SFP+ cages (Mini-GBIC; SFP module not included), DDMI support
Expansion	1x microUSB, 1x regular USB 2.0, full size Smart Card slot.
Storage	1GB Onboard NAND, microSD slot
Serial port	One RJ45 serial port
Extras	Reset switch; speed controlled fans; beeper; voltage, current and temperature monitoring
Power options	2x IEC C14 standard connectors 110/220V (Two redundant PSU)
Power consumption	100W
Operating temp.	Max ambient temperature 60°C @ 1.2GHz
Product dimensions	443x310x44.5mm
OS	MikroTik RouterOS v6, Level 6 license

mAP series

mAP is a tiny size 2.4GHz wireless Access Point with full RouterOS capabilities. Two models are available.

The mAP is dual chain 802.11 b/g/n device with two Ethernet ports. It also works as a PoE injector - the second Ethernet port provides up to 500mA of power to another device, for example, you can connect a SXT CPE device to it.

The mAP lite is dual chain 802.11 b/g/n device with one Ethernet port, barely larger than a matchbox. It comes with a built-in magnet, so you can attach it to any ferrous surface, or, if those are not available, a metallic plate with an adhesive back is also included. It can also serve as a simple configuration tool for your servers, if there is no ethernet on your mobile device, plus, it neatly attaches to the rack with it's magnet.

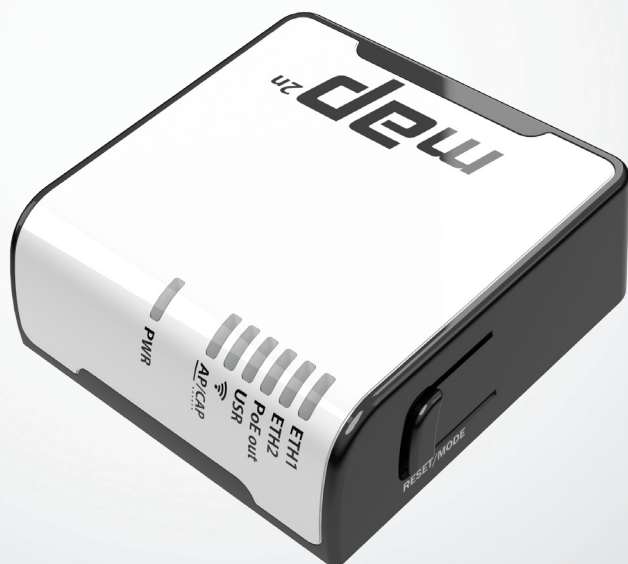
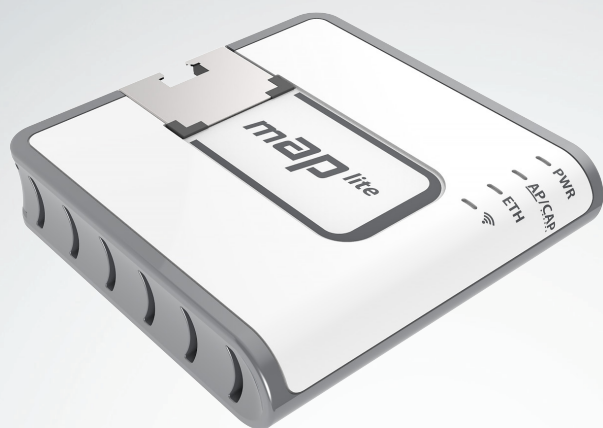

USB adapter



Power adapter



K-44 mount kit

Model	mAP	mAP lite
Product code	RBmAP2nD	RBmAPL-2nD
CPU	Qualcomm Atheros AR9531 650 MHz	QCA9533 650 MHz
RAM	64MB DDR2	64 MB DDR2
Ethernet	2x 10/100 Mbit/s Ethernet with Auto-MDI/X	1x 10/100 Mbit/s Ethernet with Auto-MDI/X
Storage	16MB built in flash storage	
Wireless	2.4 GHz 802.11b/g/n, dual-chain	
Antenna	1.2dBi built in	1.5dBi built in
Power input	Passive and 802.3af/at	
Power output	Passive PoE output, up to 500mA on Ether 2	-
Power consumption	5W	3.5 W
Case dimensions	68x68x19mm	48x49x11mm
Operating temp.	-20°C .. +70°C tested	
Extras	MicroUSB type AB	-
OS	MikroTik RouterOS, Level 4 license	
Included	mAP device, 24V 0.8A power adapter, microUSB type B to USB type A adapter.	mAP device, 5V 1A power adapter, mount kit

RBmAP2nD / RBmAPL-2nD	
1MBit/s	22dBm / -96dBm
11MBit/s	22dBm / -89dBm
6MBit/s	20dBm / -93dBm
54MBit/s	18dBm / -74dBm
MCS0	20dBm / -93dBm
MCS7	16dBm / -71dBm

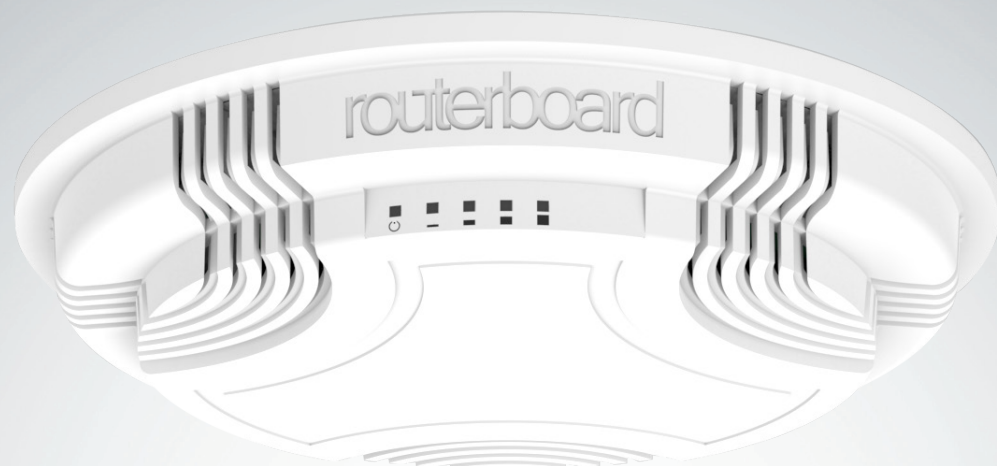

Power adapter



Ceiling mount base



Ceiling mount attachment



PoE injector

cAP

RouterBOARD cAP is our first 2.4GHz dual chain ceiling AP. Inconspicuously designed, it blends into the environment, perfect for hospitality business like hotels, airports, shopping malls etc.

cAP supports 802.11b/g/n and can be powered by PoE. It's a perfect companion for the MikroTik CAPsMAN (controlled AP system manager), allowing you to control all your AP devices from one central location.

Unlike traditional controller software, which requires a separate PC/Mac to run, our CAPsMAN runs on any existing RouterBOARD device in your network. No need for a separate controller machine.

Everything is included to get you started, wall/ceiling mount, PoE injector, power adapter and even the screws and screw anchors.

Product code	RBcAP2nD
CPU	Atheros QCA9533 650MHz network processor
Memory	64MB DDR RAM
Ethernet	One 10/100 Mbit/s Fast Ethernet port with Auto-MDI/X
Wireless	Wireless Built-in 2.4 GHz 802.11b/g/n, dual chain
Extras	Reset switch
LEDs	5x LEDs, 1x user LED
Power input	Passive or 802.3at/af PoE input, 11-56V
Consumption	4W
Dimensions	∅ 185mm, height: 31mm
Operating temperature	-20°C .. +70°C tested
Operating system	RouterOS, WISP AP (level 4) license
Package contains	24V 0.38A power adapter, PoE injector, ceiling mount base, ceiling mount attachment
Antenna	Max gain 2dBi

802.11b/g	TX power	RX Sensitivity
1MBit/s	22	-96
11MBit/s	22	-89
6MBit/s	20	-93
54MBit/s	18	-74
802.11n	TX power	RX Sensitivity
MCS0	20	-93
MCS7	16	-71

wAP

The wAP is a small weatherproof wireless access point for your mobile devices, perfect for installation outside your house, in the garden, on your porch or anywhere else where you need wireless access from your phone or computer.

We have two models available - regular wAP (2.4GHz only) and wAP ac (2.4/5GHz).

The regular wAP has one 10/100 Ethernet port, it supports 802.11b/g/n wireless standards. It looks unobtrusive and sleek, available in two colors - black (RBwAP2nD-BE) and white (RBwAP2nD).

The wAP ac has one Gigabit Ethernet port and can work at both the 2.4GHz and 5GHz frequencies simultaneously. It supports both 802.11b/g/n and 802.11ac standards. The wAP ac is also available in two colors - black (RBwAPG-5HacT2HnD-BE) and white (RBwAPG-5HacT2HnD).

The wAP is weatherproof and can be fixed to any external wall from the inside of the case - so that it is securely attached to its mounting location. The bottom door can also be secured with a special screw, which can only be opened by the owner.



Model	RBwAP2nD (white), RBwAP2nD-BE (black)	RBwAPG-5HacT2HnD (white), RBwAPG-5HacT2HnD-BE (black)
CPU	QCA9533 650 MHz	QCA9556 720 MHz
Memory	64MB RAM	
Ethernet	One 10/100 Mbit/s Fast Ethernet port with Auto-MDI/X	One 10/100/1000 Mbit/s Fast Ethernet port with Auto-MDI/X
Wireless	Built-in 2.4 GHz 802.11b/g/n, dual-chain	Built-in 2.4 GHz 802.11b/g/n, dual-chain Built-in 5 GHz 802.11a/n/ac, triple-chain
Antenna	Max gain 2dBi	
Antenna beam width	360°	
LEDs	5x LEDs, 1x user LED	
Power input	11V-57V (Passive PoE and 802.3af/at with unshielded cable)	
Consumption	4W	12W
Dimensions	185 x 85 x 30 mm	
Operating temperature	-20°C .. +70°C tested	
Operating system	RouterOS, WISP AP (level 4) license	
Package contains	Power adapter, PoE injector, ceiling mount base, ceiling mount attachment	

RBwAP2nD

2.4 GHz	Tx (dBm)	Rx (dBm)
1Mbit/s	22	-96
11Mbit/s	22	-89
6Mbit/s	20	-93
54Mbit/s	18	-74
MCS0	20	-93
MCS7	16d	-71

RBwAPG-5HacT2HnD

2.4 GHz	Tx (dBm)	Rx (dBm)	5GHz	Tx (dBm)	Rx (dBm)
1Mbit/s	25	-95	6Mbit/s	25	-96
11Mbit/s	25	-90	54Mbit/s	25	-81
6Mbit/s	25	-95	MCS0	25	-96
54Mbit/s	23	-80	MCS7	24	-77
MCS0	25	-95	MCS9	23	-72
MCS7	22	-74			



Power adapter



Screw kit



2x plastic straps



Ceiling mount base



PoE injector



hAP lite (tower case)



hAP lite (classic case)



hAP

USB power adapter 5V
0.7A (hAP lite)Power adapter 24V
0.8A (hAP)

hAP

The home Access Point (hAP) is an ideal little device for your apartment, house or office.

It supports button triggered WPS, for the convenience of not typing a complicated password when somebody wants to have wireless internet access, and can also be told to change to cAP mode and join a CAPsMAN centrally managed network by the push of a button.

Of course, the device runs RouterOS with all the features, bandwidth shaping, firewall, user access control and many others.

hAP lite is a low cost model with four Ethernet ports that comes with classic desktop case (RB941-2nD) or tower case (RB941-2nD-TC).

hAP comes with five Ethernet ports, full size USB and PoE output function for port 5 - it can power other PoE capable devices with the same voltage as applied to the unit. Maximum load on the port is 500mA.

Model	hAP	hAP lite
Product code	RB951Ui-2nD	RB941-2nD (classic case) RB941-2nD-TC (tower)
CPU	QCA9531 650MHz CPU	
Memory	64MB DDR2 RAM	32MB DDR RAM
Ethernet	5x 10/100 Mbit/s Ethernet with Auto-MDI/X	4x 10/100 Mbit/s Ethernet with Auto-MDI/X
Wireless cards	Onboard dual chain 2.4GHz 802.11b/g/n QCA9531 wireless module; 10kV ESD protection on each RF port, WPS support via button	
Extras	Reset switch	
LEDs	Power LED, 5x Ethernet LED, user LED	Power LED, 4x Ethernet LED, user LED
Power input	Packaged with 24V DC 0.8A power adapter	Packaged with 5V DC 0.7A power adapter
Power output	Yes (Ether5)	-
USB	1x USB type A	1x USB type A (power only)
Dimensions	113x89x28mm	113x89x28mm (classic case) 124x100x54mm (tower)
Max consumption	5W	3W
Operating Temp	-20C .. +70C tested	
OS	MikroTik RouterOS, Level 4 license (AP support)	

hAP and hAP lite	
TX/RX at 1Mbps	22dBm / -96dBm
TX/RX at 11Mbps	22dBm / -89dBm
TX/RX at 6Mbps	20dBm / -93dBm
TX/RX at 54Mbps	18dBm / -74dBm
TX/RX at MCS0	20dBm / -93dBm
TX/RX at MCS7	16dBm / -71dBm
Antenna	1.5dBi gain

hAP ac series

The hAP ac is a Dual-concurrent Access Point, that provides Wifi coverage for 2.4GHz and 5GHz frequencies at the same time. Two models are available.

The hAP ac lite is equipped with a 650MHz CPU, 64MB RAM, five 10/100Mbps Ethernet ports (PoE output on port #5), dual-chain 802.11b/g/n 2.4GHz wireless, single chain 802.11ac 5GHz wireless and USB port for 3G/4G modem.

The hAP ac is equipped with a 720MHz CPU, 128MB RAM, five Gigabit Ethernet ports (PoE output on port #5), triple-chain 802.11b/g/n 2.4GHz wireless, triple-chain 802.11ac 5GHz wireless, SFP cage and USB port for 3G/4G modem.

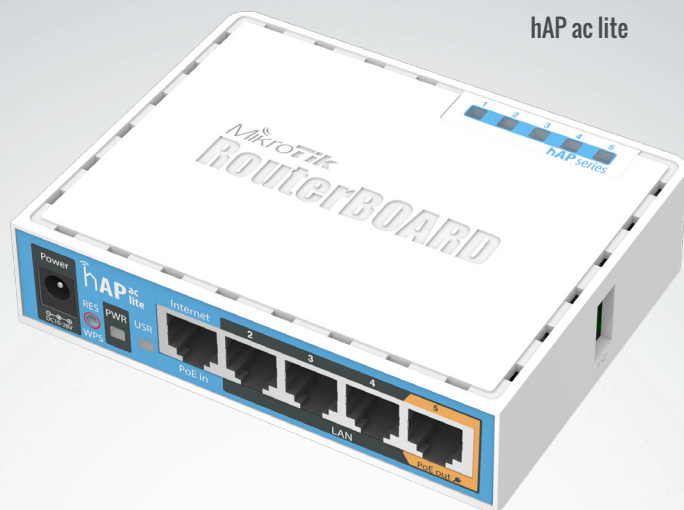

hAP ac lite



hAP ac



Power adapter 24V 1.2A

Model	hAP ac	hAP ac lite
Product code	RB962UiGS-5HacT2HnT	RB952Ui-5ac2nD (International) RB952Ui-5ac2nD-US (USA)
CPU	QCA9558 720MHz	QCA9531 650MHz
Memory	128MB DDR2 RAM	64MB DDR2 RAM
Ethernet	5x 10/100/1000 Mbit/s Ethernet with Auto-MDI/X	5x 10/100 Mbit/s Ethernet with Auto-MDI/X
Wireless	2.4GHz 802.11b/g/n QCA9558 wireless module; 5GHz 802.11ac QCA9880 wireless module;	
Number of chains	3	1
Extras	Reset switch, beeper, PCB temperature monitor, voltage monitor	Reset switch
Power input	Packaged with 24V DC 1.2A power adapter	
Power output	Yes (Ether5)	
USB	1x USB type A	
SFP	1x SFP cage	-
Dimensions	114x137x29mm	113x89x28mm
Max consumption	17W	7W
Operating Temp	-20C .. +70C tested	
OS	MikroTik RouterOS, Level 4 license (AP support)	

	hAP ac		hAP ac lite	
	2.4GHz	5GHz	2.4GHz	5GHz
TX/RX at 1Mbps	29dBm / -100dBm	-	22dBm / -96dBm	-
TX/RX at 11Mbps	29dBm / -94dBm	-	22dBm / -89dBm	-
TX/RX at 6Mbps	29dBm / -96dBm	28dBm / -96dBm	20dBm / -93dBm	23dBm / -93dBm
TX/RX at 54Mbps	26dBm / -81dBm	25dBm / -81dBm	18dBm / -74dBm	20dBm / -75dBm
TX/RX at MCS0	29dBm / -96dBm	28dBm / -96dBm	20dBm / -93dBm	23dBm / -93dBm
TX/RX at MCS7	25dBm / -77dBm	24dBm / -77dBm	16dBm / -71dBm	19dBm / -71dBm
TX/RX at MCS9	-	21dBm / -72dBm	-	16dBm / -63dBm
Antenna	2.5dBi gain	2dBi gain	1.5dBi gain	2dBi gain

RB951 high power series

The RB951 High Power is a wireless SOHO AP with a new generation Atheros CPU and more processing power. It has 600MHz CPU, 128MB RAM, high power 2.4GHz 1000mW 802.11b/g/n wireless AP with antennas built in and USB port for external 3G/4G modem. The device is very small and will look good in any home or office, wall mounting anchor holes are provided.

Two models are available:

- The RB951G-2HnD has five Gigabit Ethernet ports;
- The RB951Ui-2HnD has five 10/100Mbps Ethernet ports and PoE output function for port 5 - it can power other PoE capable devices with the same voltage as applied to the unit. Maximum load on the port is 500mA.



RB951G-2HnD



12V 1A adapter



RB951Ui-2HnD



24V 0.8A adapter

Model	RB951G-2HnD	RB951Ui-2HnD
Features	Gigabit, USB, 2GHz, 802.11n, dual chain	USB, power injector, 2GHz, 802.11n, dual chain
CPU	Atheros AR9344 600MHz CPU	
Memory	128MB DDR2 onboard memory	
Ethernet	Five independent 10/100/1000 Gigabit Ethernet ports	Five independent 10/100 Ethernet ports
LEDs	Power, NAND activity, 5 Ethernet LEDs, wireless activity LED	
Power input	PoE in: 8-30V DC on Ether1 (Non 802.3af). Jack: 8-30V DC	
Power out	-	PoE out passive on port 5, same voltage as input, max: 500 mA
Dimensions	113x138x29mm	
Power consumption	Up to 7W	
Operating temp.	-20°C .. +70°C tested	
Operating System	MikroTik RouterOS, Level 4 license	
Package contains	RouterBOARD in a plastic case, power adapter (12V, 1A)	RouterBOARD in a plastic case, power adapter (24V 0.8A)

Antennas	2x2 MIMO PIF antennas, max gain 2.5dBi
RX sensitivity	802.11g: -96dBm @ 6Mbit/s to -80dBm @ 54Mbit/s 802.11n: -96dBm @ MCS0 to -78dBm @ MCS7
TX power	802.11g: 30dBm @ 6Mbps to 25dBm @ 54 Mbps 802.11n: 30dBm @ MCS0 to 23dBm @ MCS7
Modulations	OFDM: BPSK, QPSK, 16 QAM, 64QAM DSSS: DBPSK, DQPSK, CCK

RB2011UiAS-2HnD-IN

RouterBOARD 2011UiAS-2HnD has most features and interfaces from all our Wireless routers. It's powered by the new Atheros 600MHz 74K MIPS network processor, has 128MB RAM, five Gigabit LAN ports, five Fast Ethernet LAN ports and SFP cage (SFP module not included!). Also, it features powerful (up to 1W!) dual chain 2.4Ghz 802.11bgn wireless, RJ45 serial port, microUSB port and RouterOS Level 5 license.

RB2011UiAS-2HnD-IN comes with desktop enclosure, two indoor antennas for wireless, power supply and touchscreen LCD panel.



Power adapter



USB cable

General specifications	
CPU	Atheros AR9344 600MHz
Memory	128MB DDR2 SDRAM onboard memory
Ethernet	Five 10/100 Mbit Fast Ethernet ports with Auto-MDI/X Five 10/100/1000 Mbit Gigabit Ethernet ports with Auto-MDI/X
Wireless	Built in 2GHz dual chain 802.11b/g/n wireless device Also includes two 2.5dBi swivel antennas
Expansion	One fixed Gigabit Ethernet SFP cage (Mini-GBIC; SFP module not included)
Extras	Reset button, Reset jumper, RJ45 serial port, LCD panel, Temperature and Voltage sensors, powered micro-B USB connector, Beeper
Power input	Jack 8-28V DC; PoE in: 8-28V DC on Ether1 (Non 802.3af), 11W max consumption
Power output	500mA on Port 10
Operating temperature	-20°C .. +70°C tested
Dimensions	214mm x 86mm
Operating System	MikroTik RouterOS, Level 5 license
Package includes	RB2011, power supply, USB cable

Feature / Model	2011UiAS-2HnD-IN
Enclosure	Desktop
SFP port	Yes
Serial port	Yes
USB	Yes
Wireless	Yes
Antennas	2x built in 4dBi swivel
LCD display	Yes

802.11b/g	RX Sensitivity	TX Power	802.11n	RX Sensitivity	TX power
1Mbit	-96	30dBm	MCS0/8 20MHz	-95	30dBm
11Mbit	-80	28dBm	MCS0/8 40MHz	-92	30dBm
6Mbit	-96	30dBm	MCS7/15 20MHz	-76	25dBm
54Mbit	-80	27dBm	MCS7/15 40MHz	-73	25dBm

RB411

Perfect for building custom AP and CPE devices

The RB411 are our low cost customizable routers with one Ethernet and one miniPCI slot. The new RB411L series are lower cost, and don't have some of the ports present on other RB411 devices. There are six models in the RB411 series.

Use this device in an outdoor case for a AP/CPE device, or a point to point wireless link installation. The miniPCI slot allows you to choose your own preferred wireless card model.

Data storage	NAND memory chip
Ethernet	One 10/100 Mbit/s Ethernet port with Auto-MDI/X
miniPCI	One MiniPCI Type IIIA/IIIB slot
Extras	Reset switch, beeper
LEDs	Power, NAND activity, 5 user LEDs
Power input	PoE in: 8-28V DC on Ether1 (Non 802.3af).
Operating temperature	-40°C .. +70°C tested
Dimensions	105x105mm
Power consumption	1,4W board only, 10W available to miniPCI card
Operating System	MikroTik RouterOS

Feature / Model	411L	411	411U	411AR	411AH	411GL
CPU MHz	300	300	300	300	680	680
RAM MB	32	32	32	32	64	64
Power jack	-	yes	yes	yes	yes	yes
Serial port	-	yes	yes	yes	yes	-
USB	-	-	yes	-	-	yes
miniPCI express	-	-	yes	-	-	-
Integrated wireless	-	-	-	2.4GHz	-	-
Gigabit LAN	-	-	-	-	-	yes
RouterOS License	Level 3	Level 3	Level 4	Level 4	Level 4	Level 4

RB411AR

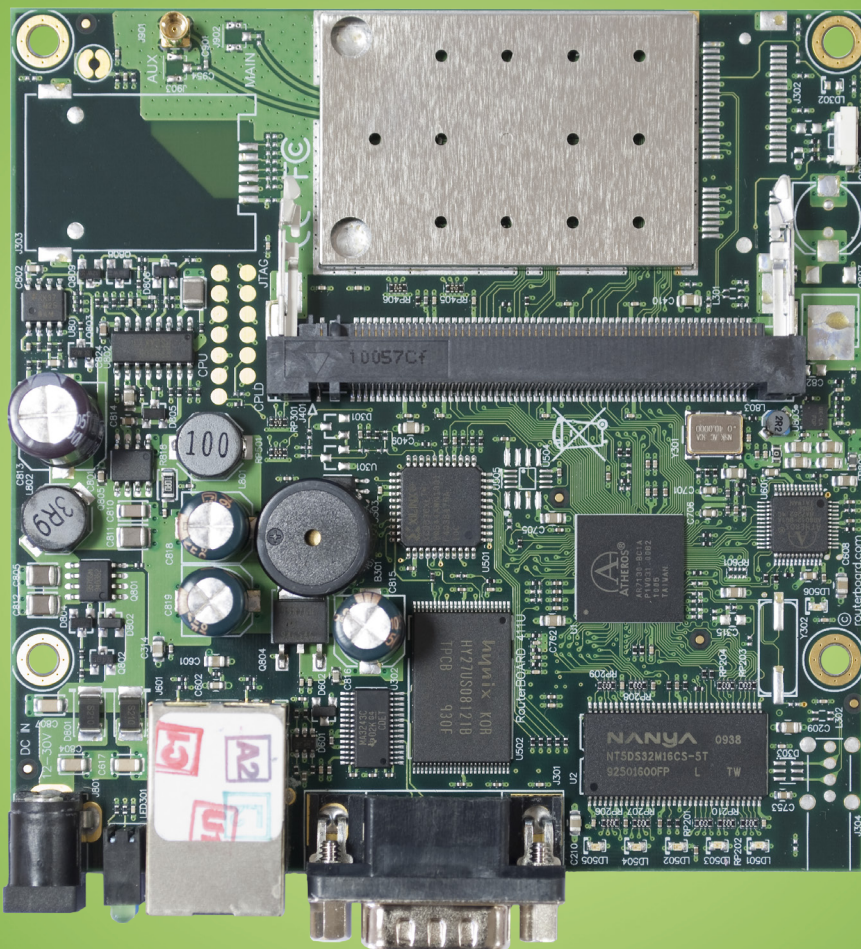

RB433

Perfect for building custom AP devices

The RB433 is a multi port device. Use it in an outdoor case for a sector AP installation, or for a wireless backhaul. Three ports give you plenty of configuration options for many wireless scenarios.

New to the RB433 family is the RB433L series - a light version with only the most essential features and available at a lower cost.

We currently have four different models in the RB433 series.

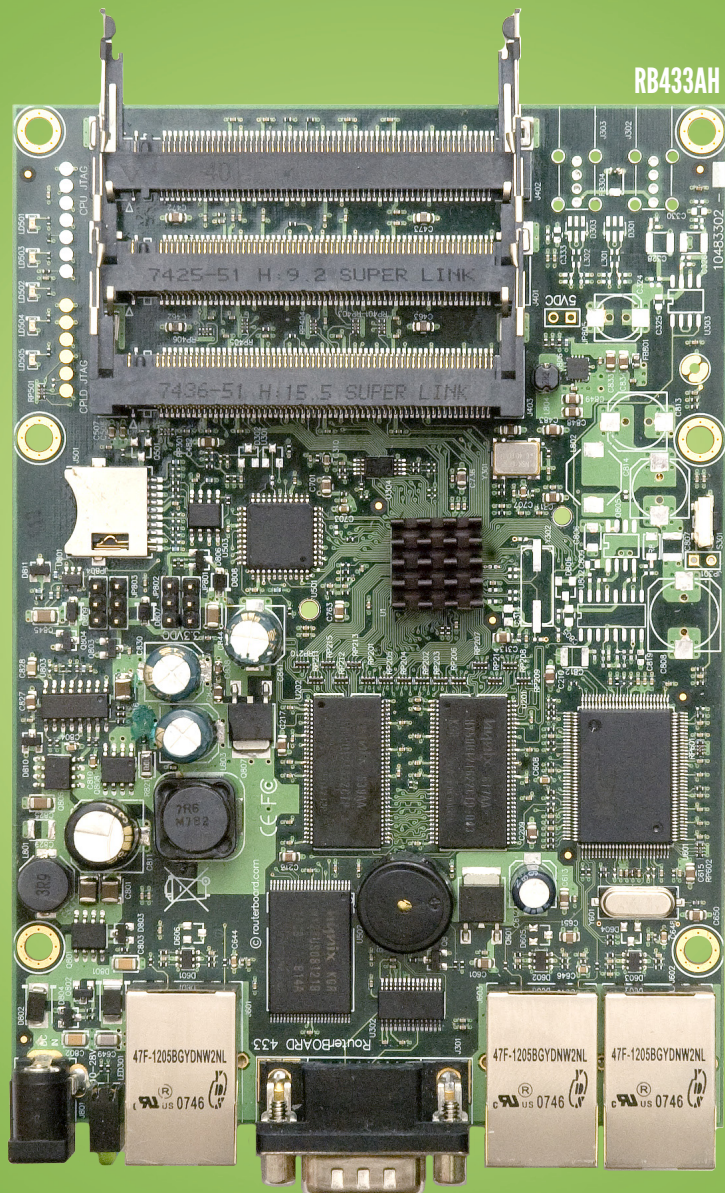

CPU	Atheros AR7130/ AR7161
Memory	DDR SDRAM onboard memory
Boot loader	RouterBOOT
Data storage	NAND memory chip
Ethernet	Three 10/100 Mbit/s Ethernet ports with Auto-MDI/X
miniPCI	Three MiniPCI Type IIIA/IIIB slots
Extras	Reset switch, beeper, voltage monitor
LEDs	Power, NAND activity, 5 user LEDs
Power input	PoE in: 8-28V DC on Ether1 (Non 802.3af), Power jack (8-28V DC)
Operating temperature	-40°C .. +70°C tested
Dimensions	105x154mm
Power consumption	2W board only, 14W available to minIPCI cards
Operating System	MikroTik RouterOS

Feature / Model	433UL	433	433AH	433GL
CPU MHz	300Mhz	300Mhz	680Mhz	680Mhz
RAM MB	64MB	64MB	128MB	128MB
Serial port	-	yes	yes	-
USB	yes	-	-	yes
Gigabit LAN	-	-	-	Yes
RouterOS License	Level 4	Level 4	Level 5	Level 5

RB435G

Five miniPCI slots and three Gigabit Ethernet ports give you enough connectivity options to use the RB435G as the central part of your network. Now with Gigabit ports, to properly utilize all the speed 802.11n with Nv2 wireless.

Five miniPCI slots to be used for four sectors and a backbone, or any other configuration you need.

The two USB 2.0 ports can be used for extending storage, adding a 3G wireless modem for backup connectivity, for a mobile installation or all together.

The RB435G comes with a 680MHz Atheros CPU and is preinstalled with a Level 5 RouterOS license.

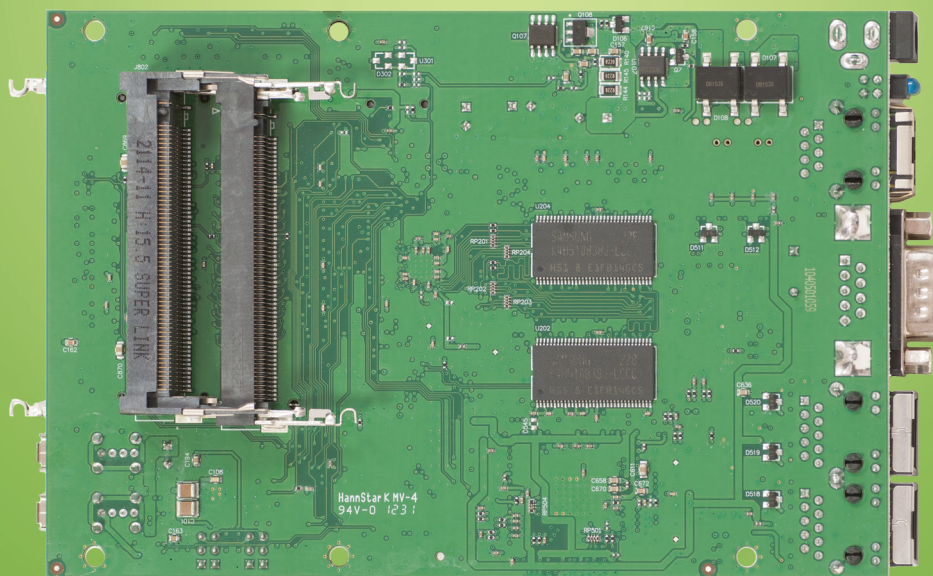
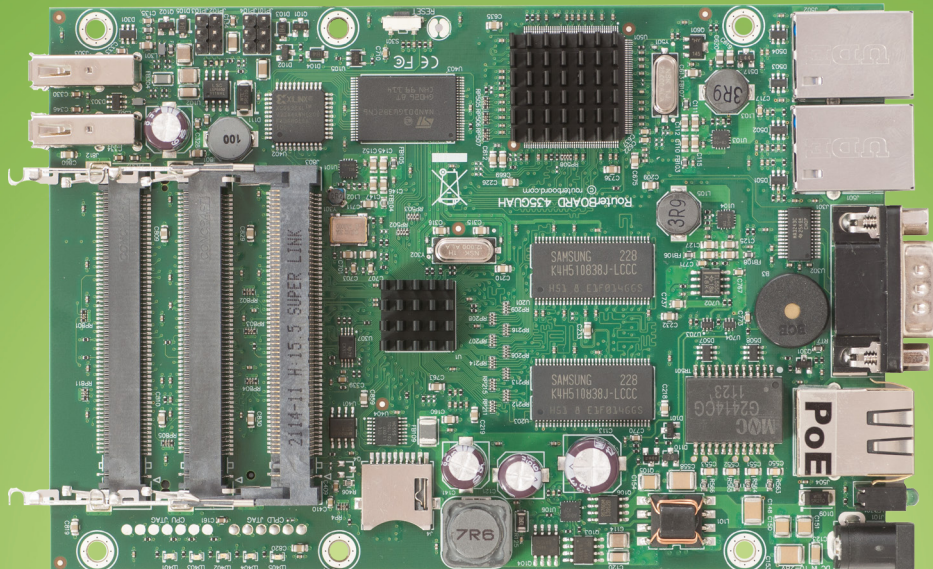

CPU	Atheros AR7161 680MHz
Memory	256MB DDR SDRAM onboard memory
Boot loader	RouterBOOT
Data storage	NAND memory chip and microSD slot for expansion
Ethernet	Three 10/100/1000 Gigabit Ethernet ports with Auto-MDI/X
miniPCI	Five miniPCI Type IIIA/IIIB slots
Expansion	Two USB 2.0 ports with powering (5V 1A supply)
Extras	Reset switch, beeper, temperature, voltage and current monitors
Serial port	One DB9 RS232C asynchronous serial port
LEDs	Power, NAND activity, 5 user LEDs
Power input	PoE in: 8-28V DC on Ether1 (Non 802.3af). Jack: 8-30V DC
Operating temperature	-40°C .. +70°C tested
Dimensions	105x154mm
Power consumption	~4.5W without extension cards
Output to cards	19W without any cooling, up to 40W with active cooling
Operating System	MikroTik RouterOS, Level 5 license

RB850/450

The RB450/RB850 is our five Ethernet port RouterBOARD line with DB9 RS232C serial port.

Three models with same form factor are available:

- RB450 - basic model with 300Mhz CPU, 32MB RAM and five 10/100Mbps Ethernet ports;
- RB450G- advanced model with 680Mhz CPU, 256MB RAM, five Gigabit Ethernet ports and microSD slot;
- RB850Gx2 - new generation model with dual core CPU, 512MB RAM, five Gigabit Ethernet ports and microSD slot.

RB850Gx2

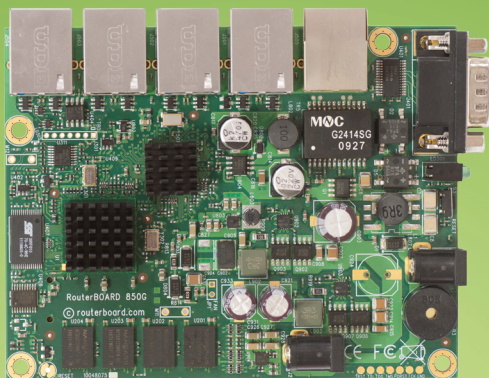

RB450G

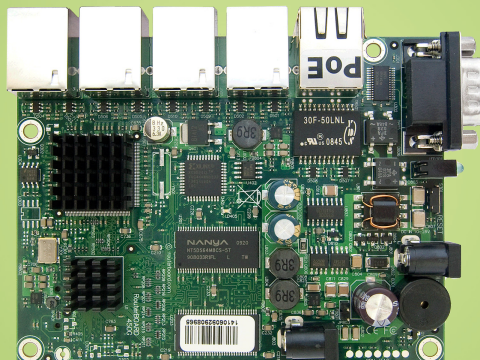

RB450

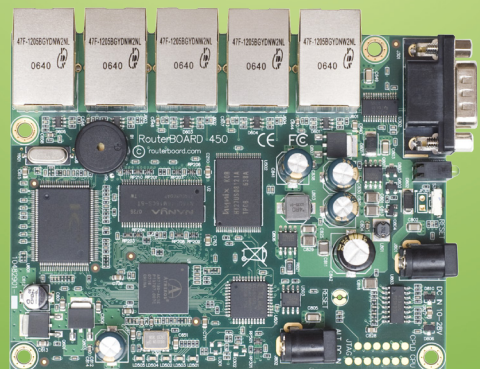

Model	RB850Gx2	RB450G	RB450
CPU	P1023 533MHz (Dual core)	AR7161 680MHz	AR7130 300MHz
Memory	512MB DDR3 667MHz RAM	256MB DDR SDRAM	32MB DDR SDRAM
Data storage	512MB NAND memory chip, microSD slot		128MB NAND memory chip
Ethernet	Five 10/100/1000 Mbit/s Gigabit ports with Auto-MDI/X, Hardware switch chip and port mirror support		Five 10/100 Mbit/s Ethernet ports with Auto-MDI/X, Hardware switch chip and port mirror support
Extras	Reset switch, beeper, voltage and temperature monitors	Reset switch, beeper, voltage and temperature monitors	Reset switch, beeper, voltage and temperature monitors
Serial port	One DB9 RS232C asynchronous serial port		
LEDs	Power, NAND activity, 5 user LEDs		
Power input	PoE in: 8-28V DC on Ether1 (Non 802.3af). Jack: 8-30V DC		
Operating temp.	-40°C .. +70°C tested		
Power consumption	8W	6W	4W
Dimensions	90x115mm		
RouterOS License	Level 5		

RB493

The RB493 has nine ethernet ports and three miniPCI slots, it also has a switch chip, so the ethernet ports of your choice can be grouped together to make it act as a switch.

RB493 includes RouterOS - the operating system, which will turn this powerful system into a highly sophisticated router, firewall or bandwidth manager.

With nine Ethernet ports, and three miniPCI slots, this is our most versatile RouterBOARD model.

The RB493AH model includes the higher speed Atheros 680MHz CPU, more memory, and a Level5 license for more a simultaneous tunnel interfaces and hotspot users and RB493G adds a Gigabit port and a USB port.

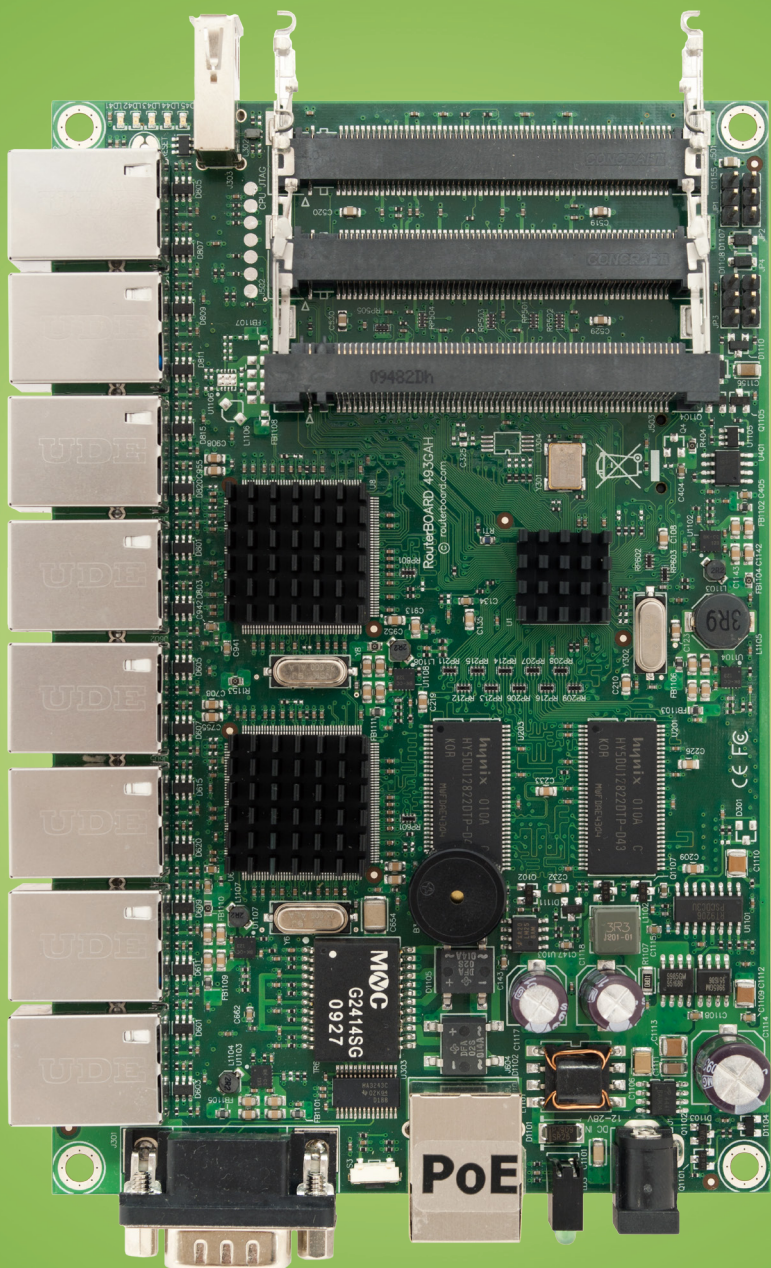

Model	RB493AH	RB493G
CPU	AR7161 680MHz	AR7161 680MHz
RAM	128MB	128MB
External storage	-	microSD
Ethernet	Nine 10/100 Mbit/s	Nine 10/100/1000 Gbit/s
miniPCI	Three miniPCI slots	
Extras		1x unpowered USB 2.0 port, temperature and voltage sensors
Serial port	One DB9 RS232C asynchronous serial port	
LEDs	Power, NAND activity, 5 user LEDs	
Power options	PoE: 8-28V DC on Ether1 (Non 802.3af). Jack: 8-30V DC	
Dimensions	105mm x 160mm, 189 grams	
Consumption	~3W without extension cards, maximum – 16 W	
License	Level 5 license	

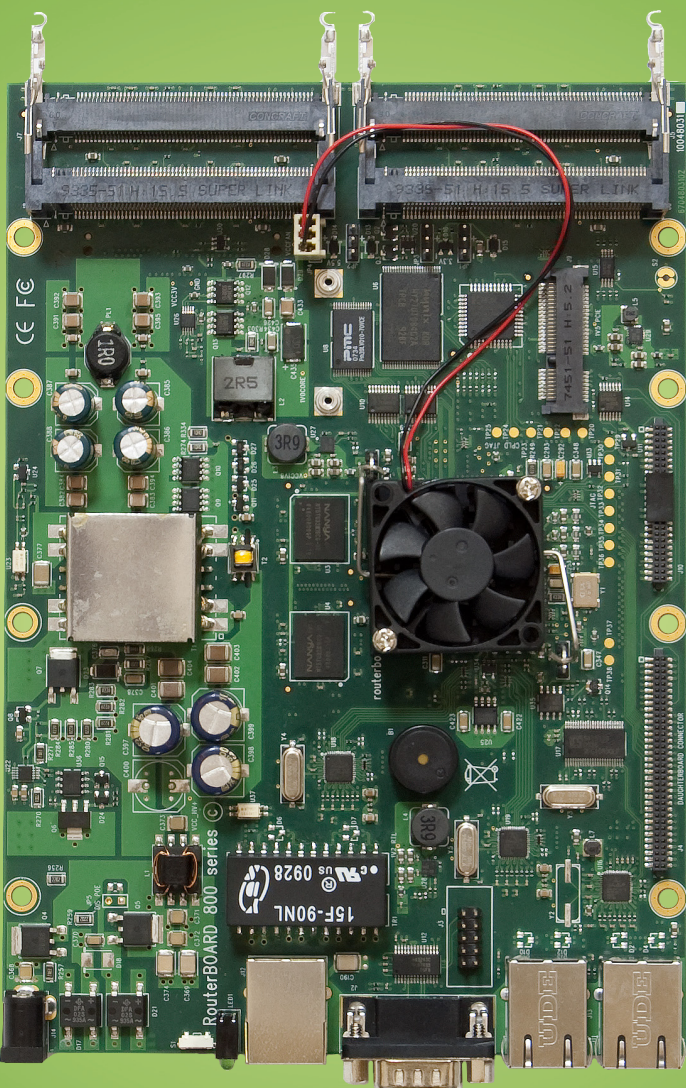

RB800

The RB800 is an advanced high performance wireless platform. It has four miniPCI slots, three Gigabit Ethernet ports, two daughterboard connectors, a miniPCI-e slot and a compact flash slot.

The two daughterboard connectors allow you to expand the number of wired and wireless ports, and the new high power CPU is capable of supporting them all. You can use various daughterboards to expand the number of interfaces on this device - RB502 and RB604 are available separately.

Combined with RouterOS - RB800 is the most powerful and sophisticated wireless router, firewall and bandwidth manager. With many expansion options. Our top of the line wireless device.

CPU	MPC8544 800MHz
Memory	256MB DDR2 SDRAM onboard memory
Boot loader	RouterBOOT
Data storage	NAND memory chip, CF slot on back
Ethernet	Three 10/100/1000 Mbit/s Ethernet ports with Auto-MDI/X
miniPCI	4 x miniPCI, 1 x miniPCI-e
Expansion	PCI daughterboard port
Extras	Reset switch, beeper, 4x fan headers, voltage and temperature sensors
Serial port	One DB9 RS232C asynchronous serial port, One serial port header
LEDs	Power, 1x User LED
Power input	PoE in: 36-56V DC (including power over datalines) Power jack: 10-56V DC
Operating temperature	-40°C .. +70°C tested
Dimensions	140x200mm
Operating System	MikroTik RouterOS, Level 6 license

RB953GS-5HnT-RP

RouterBOARD 953GS-5HnT-RP is our first product with 5GHz 3x3 MIMO Triple Chain support. It has powerful (up to 1600mW!) Atheros QCA9558 802.11a/n wireless chip with three RPSMA connectors onboard.

RB953GS-5HnT-RP is equipped with new Scorpion 720Mhz CPU, 128MB RAM and three Gigabit Ethernet ports, to take advantage of high-speed 3x3 MIMO wireless. Moreover, it comes with two SFP cages to accommodate FTTH requirements.

Handy additions are two miniPCI-express slots and two SIM slots, for multiple 3G/4G connections or wireless expansion.

Unit comes with preinstalled RouterOS Level 5 license.

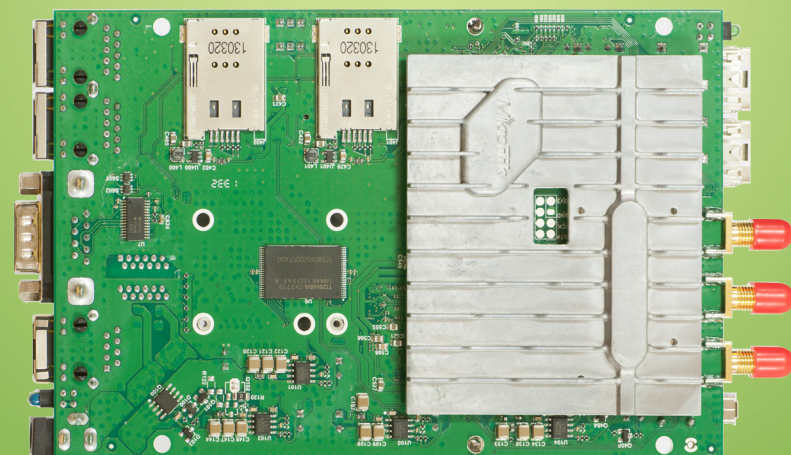
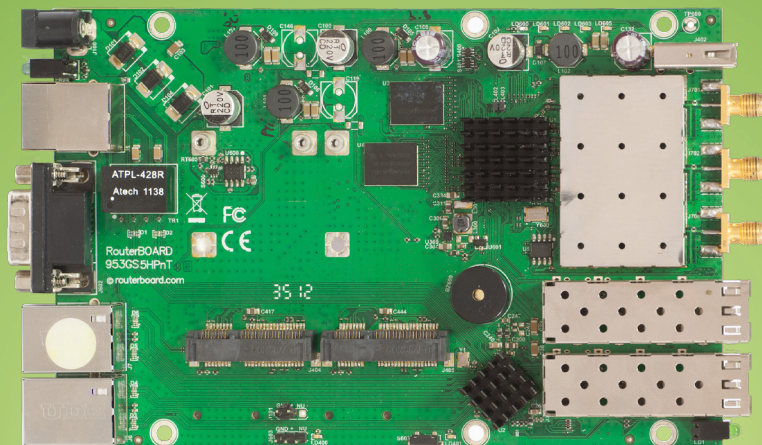

Model	953GS-5HnT-RP
CPU	QCA9558 720MHz
Memory	128MB DDR2 onboard memory
Data storage	NAND 128MB memory chip
Ethernet	3x10/100/1000 Gigabit Ethernet ports with Auto-MDI/X
Wireless	Built-in 5GHz 802.11a/n, three chains, 3x RPSMA connectors
miniPCle	2x MiniPCle slots for 802.11 or 3G (using 3G disables the USB port)
SFP	2x SFP cages
Switching chip	AR8327
Extras	PCB temperature monitor, voltage monitor, 2x fan headers, beeper, 1x USB, 2x SIM slots (for use with 3G modems that need to be installed in the miniPCle slot)
Serial Port	1x DB9 RS232C asynchronous serial port, 1x serial port header
LEDs	9x total, 6x user LEDs
Power input	PoE in: 8-30V, Power jack: 8-30V DC
Operating temperature	-40°C .. +70°C tested
Dimensions	183x105x24mm
Power consumption	25W
Operating System	MikroTik RouterOS, WISP AP (Level 5) license

	TX power / RX sensitivity
TX/RX at MCS0	32dBm / -96dBm
TX/RX at MCS7	29dBm / -77dBm
TX/RX at 6Mbit	32dBm / -96dBm
TX/RX at 54Mbit	30dBm / -81dBm
Frequency range	4900-5920MHz

RB911 Series

The RB911 series devices are perfect for building low cost CPE devices, and now a new model has been added to our line up - with 802.11ac support, to reach speeds not possible before.

The RB911 series are small wireless routers with an integrated wireless cards. They are equipped with powerful CPU, providing superb value for money.

These devices include RouterOS, the operating system which can be a router, firewall, bandwidth manager, a CPE and more, all at the same time. All devices have built-in 16kV ESD protection on the RF port.

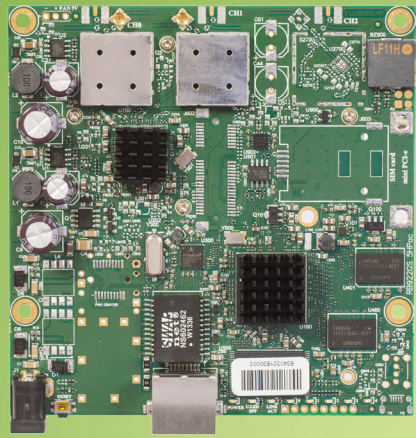

RB911G-5HPacD

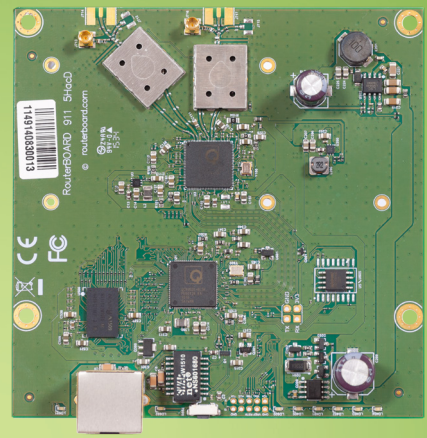

RB911-5HacD

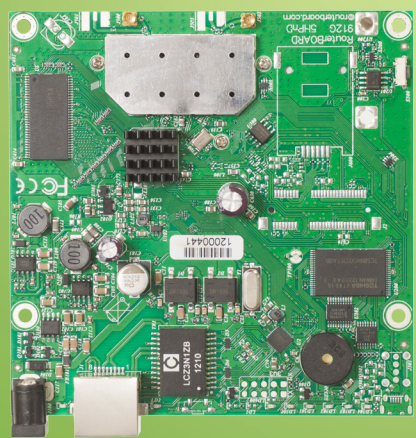

RB911G-5HPnD

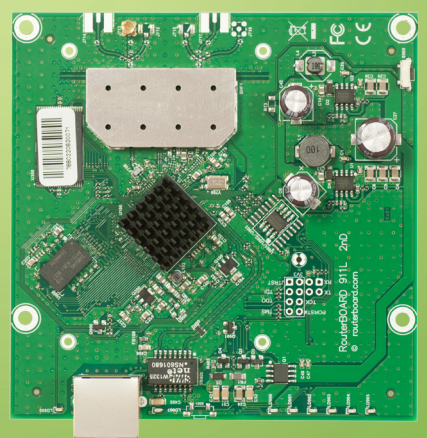

RB911-2Hn

Model	RB911-5Hn	RB911-5HnD	RB911-2Hn	RB911G-5HPnD	RB911G-2HPnD	RB911-5HacD	RB911G-5HPacD
Band	5GHz	5GHz	2.4GHz	5GHz	2.4GHz	5GHz	5GHz
Chains	1	2	1	2	2	2	2
Gigabit	-	-	-	+	+	-	+
802.11ac	-	-	-	-	-	+	+
High Power	-	-	-	+	+	+	+
Power jack	-	-	-	+	+	-	+
Consumption	5W	7W	4W	11W	11W	7W	12W
Beeper	-	-	-	+	+	-	+
Voltage monitor	-	-	-	+	+	-	+
PCB temperature monitor	-	-	-	+	+	-	+
Supported channels	20/40MHz				20/40/80MHz		
Max TX power	23dBm	26dBm	24dBm	30dBm	30dBm	29dBm	31dBm
Dimensions	105x105mm						
Power input	PoE in: 8-30V DC on Eth 1 (Non 802.3af)						
Operating temp.	-40°C .. +70°C tested						
RouterOS Licence	WISP CPE (Level 3) license						

RB912

The RB912 is a small wireless router with an integrated high power wireless card and an additional miniPCIe slot for 802.11 wireless, or 3G card. Both 2GHz and 5GHz models are available. The Gigabit port helps to utilize the full potential of 802.11n wireless speeds.

The integrated wireless card is capable of up to 1000mW output power. It has built in 16kV ESD protection on both the Ethernet and the MMCX ports.

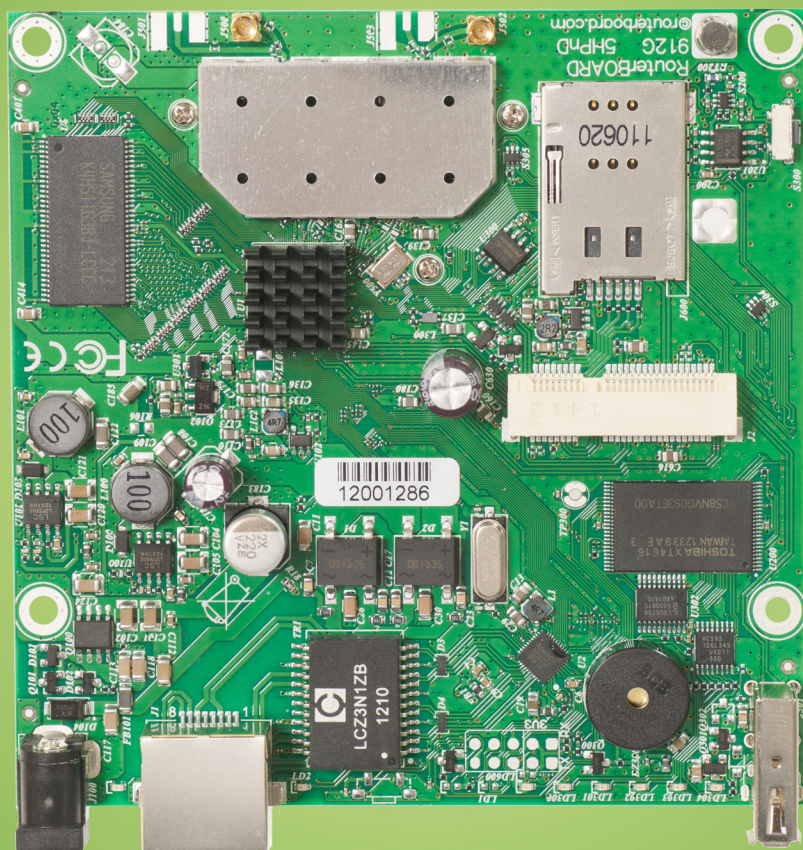

Model	RB912UAG-5HPnD	RB912UAG-2HPnD
Features	1 Ethernet, 1 miniPCIe, USB, Additional memory, Gigabit, High power, Dual chain	
CPU	Atheros AR9342 600MHz network processor	
Memory	64MB DDR onboard memory	
Data storage	onboard NAND memory chip	
Ethernet	One Gigabit port with Auto-MDI/X	
Wireless	Built in 5GHz 802.11a/n, 2x MMCX connectors	Built in 2GHz 802.11b/g/n, 2x MMCX connectors
Extras	beeper, signal and status LEDs, SIM slot (requires 3g miniPCIe card), voltage and temperature sensors	
Expansion	miniPCIe slot for 802.11 or 3G (using 3G disables the USB port), USB 2.0 port	
Power input	PoE in: 8-30V DC on Ether1 (Non 802.3af).	
Operating temp.	-40°C .. +70°C tested	
Dimensions	105x105mm	
Max consumption	14W at 24V	
OS	MikroTik RouterOS, Level 4 license (supports wireless AP mode)	

	RB912UAG-5HPnD	RB912UAG-2HPnD
TX/RX at MCS0	30dBm / -96dBm	30dBm / -96dBm
TX/RX at MCS7	24dBm / -78dBm	24dBm / -78dBm
TX/RX at 6Mbit	30dBm / -96dBm	30dBm / -96dBm
TX/RX at 54Mbit	27dBm / -80dBm	27dBm / -80dBm
Frequency range	4900-5920MHz	2400MHz-2500MHz

RB922UAGS-5HPacD

The RB922 is a very versatile wireless router, perfect for assembling your own solution. It supports the new 802.11ac standard for high speed wireless (up to 866Mbit datarate and 20/40/80MHz channels). The device has ports and slots for many uses: 1x SFP cage, miniPCIe slot with SIM for 3G/4G modem, USB port, Gigabit Ethernet port and two MMCX connectors for the built in 802.11ac radio.

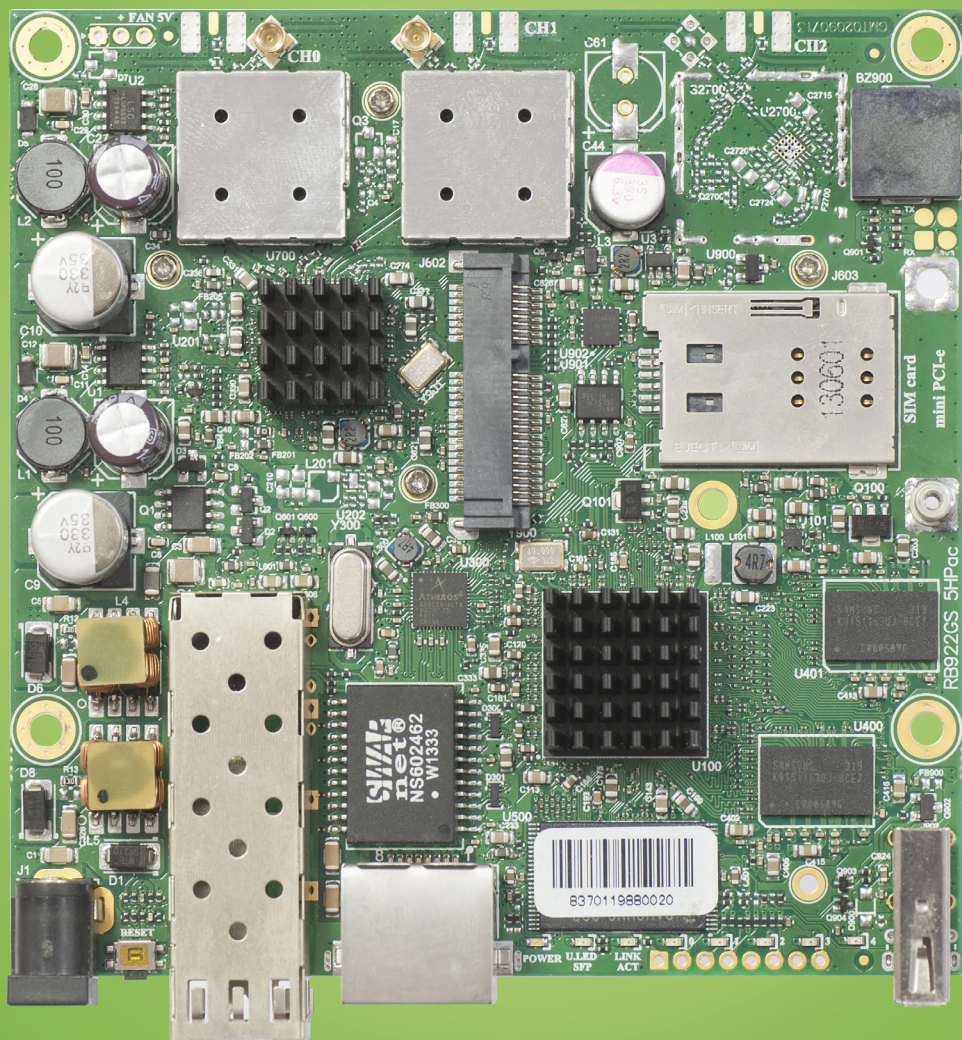

Order code	RB922UAGS-5HPacD
CPU	QCA9557 720MHz network processor
Memory	128MB DDR2 onboard memory
Ethernet	One Gigabit port with Auto-MDI/X
Wireless	QCA9882 5GHz 802.11ac, 2x MMCXconnectors, Dual chain
Supported channels	20/40/80MHz
SFP	1x SFP cage available
Extras	Beeper, signal and status LEDs, voltage and temperature sensors
Expansion	USB 2.0 port, 1x MiniPCIe slot, SIM slot (requires 3g miniPCIe card)
Power input	PoE in: 8-30V DC on Ether1 (Non 802.3af). Consumption: 17W
Operating temp.	-40°C .. +70°C tested
Dimensions	105x105mm
OS	MikroTik RouterOS, Level 4 license

Wireless transmit/receive specifications	
TX/RX at MCS0	30dBm / -96dBm
TX/RX at MCS7	27dBm / -77dBm
TX/RX at MCS9	22dBm / -72dBm
TX/RX at 6Mbit	31dBm / -96dBm
TX/RX at 54Mbit	27dBm / -81dBm
Frequency range	4920-6100 MHz, Operating range limited by Country Regulations

mANT series

The new sector mANT antennas are the perfect companion for the BaseBox, NetBox, NetMetal or any other outdoor wireless device.

The mANT is a dual-polarization antenna with two RP-SMA connectors, it comes in two sizes, the 15dBi model and the 19dBi model. Both antennas have 120 degree beamwidth.

The mANT 15s is compatible with the SXT type mount, so you can use it with our durable and adjustable QuickMount systems. It comes with quickMOUNT PRO and the mANT 19s comes with metallic U bolt type mounts.



Model	mANT 15s	mANT 19s
Product code	MTAS-5G-15D120	MTAS-5G-19D120
Antenna gain	15 dBi	19 dBi
Frequency range	5.17 - 5.825 GHz	5.17 - 5.825 GHz
Polarization	Vertical and horizontal	Vertical and horizontal
3DB Beamwidth - azimuth	120 deg	120 deg
3DB Beamwidth - elevation	10 deg	5 deg
VSWR	1.43 typ, 1.8 max	1.43 typ, 1.8 max
Port to Port isolation	>40 dB min	>40 dB min
Front-to-Back ratio	>30 dB	>30 dB
Cross Polarization	>30 dB	>30 dB
Weight	Package: 1.35 Kg Unit: 816g	Package: 3.01 Kg Unit: 1,36 Kg
Dimensions	140 x 348 x 82 mm	152 x 598 x 78 mm

mANT30 series

mANT30 is a professional class 5 GHz 30dBi dish antenna, built to the highest industry standards. Built to seamlessly accommodate our BaseBox and NetMetal series products, also NetBox, but can be used for any pole mounted wireless device due to the adequate length of the included FlexGuide cable.

Two antennas are available, with a **standard type mount (MTAD-5G-30D3)**, and with a **precision alignment mount (MTAD-5G-30D3-PA)**. The antennas come packaged with all necessary accessories and cables.

Electrical Specifications

Frequency Range	4.7-5.875 GHz
Gain	30 dBi typically
Polarization	Dual (Vertical and Horizontal)
3dB Beamwidth	3 deg
Standards	Complies with EN 302 326 DN1, DN2, DN3, DN5
VSWR	≤ 1.4 typ, ≤ 1.8 max
Port to Port Isolation	>40dB min
Front-to-Back Ratio	>30 dB
Cross Polarization	>40 dB
Power Rating	100 watts
Impedance	50 ohms
Elevation adjustment range	+/- 20 deg (MTAD-5G-30D3), +/- 15 deg (MTAD-5G-30D-PA)

Horizontal polarization

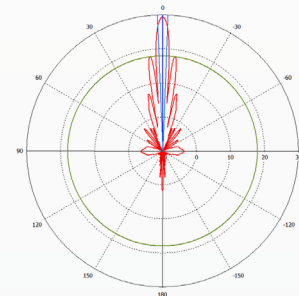

Physical/Environmental Specifications

Diameter x Depth	70 x 45cm (27.5 x 17.8in)
Weight neto	5.7kg (12.6 lbs) PA and 4.8kg (10.7 lbs) standard version
Reflector	Aluminum
Outdoor Rating	ETSI EN 300 019-2-4
Wind Survivability	201kph (125mph)
Wind Load (125 mph)	181.4kg (400 lbs)
Operating temperature	-40°C .. 70°C tested
Pole Mount Diameter Range	(MTAD-5G-30D3): 3 to 7cm (1.2 to 2.75in) (MTAD-5G-30D-PA): 3 to 10cm (1.2 to 3.9in)
Connector (2)	RP-SMA Female (outside thread)
Packaged size	73x73x20cm (29x29x8in)
Packaged weight	(MTAD-5G-30D3): 7.5 kg (16.5 lbs), (MTAD-5G-30D3-PA): 8.4 kg (18.5)
Compatible with	Can directly mount Basebox and other future RouterBOARD devices, or accept any pole-mounted device
Package includes	FlexGuide RPSMA RF Cables (RP-SMA-male to RP-SMA-male) x 2pcs; Bracket for mounting BASEBOX series radio; Self-Bonding Tape for insulating the RF cables x 2 slices; Precise alignment mechanisms (PA Version only)

Vertical polarization

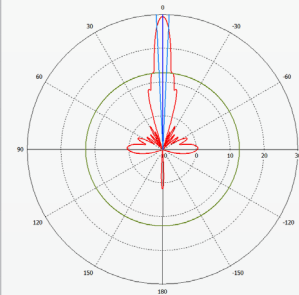

MTAD-5G-30D3
(With standard type mount)

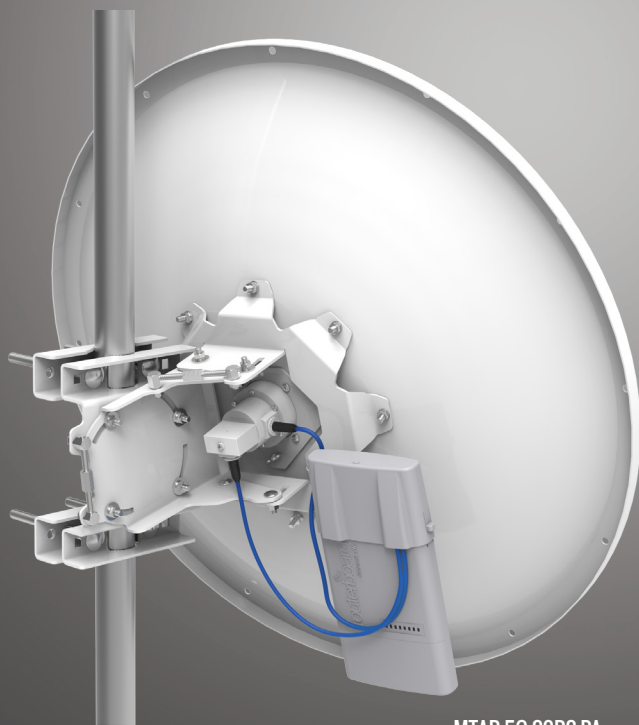
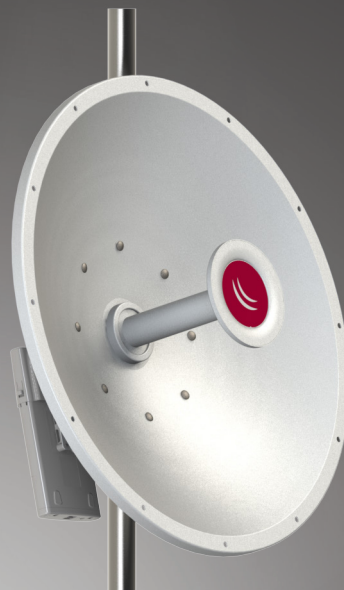

MTAD-5G-30D3-PA
(With precision alignment mount)

Available separately, the Radome reduces wind load, protects reflector surfaces from harsh environment.

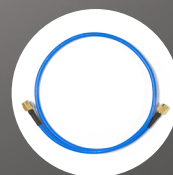

FlexGuide

Note: Basebox radio not included, available separately.

Sleeve30 Kit

The Sleeve30 kit for our mANT30 parabolic antenna will enhance point-to-point link performance by reducing noise and will also reduce impact on adjacent RF devices by removing the side radiation from the antenna.

Additional and co-channel interference creates unwanted signal attenuation that causes decrease of link quality and speed. Using Sleeve30 Kit with mANT30 gives 22dB additional selectivity for each mANT30 in a critical direction, see the picture below. Using Sleeve30 Kits for two mANT30 devices side by side provides extra 44dB selectivity.

Such improvement allows several mANT30's + Sleeve30's to freely work at one place, at the same channels, without interfering with each other.

Sleeve30 Kit also reduces wind load and protects antenna reflector and feed from harsh environment, improving PtP link sustainability.

Sleeve30 shell is made of corrosion resistive, lightweight aluminum; front cover has excellent RF signal transparency.



Product code	Sleeve30
Assembled Sleeve30 dimensions	700x700x220mm
Box dimensions	720x715x230mm
Weight netto	2.95 kg
Weight bruto	5.520kg
Box contents	aluminum shell, front cover, fasteners, silicone sealant

quickMOUNT

QuickMOUNT is a wall mount adapter for point to point and sector antennas. You can mount it on the wall or use it as an adapter from large diameter pole to small size antenna mounting clip ensuring reliable fitment. The adapter is very durable due to its special material composite - anvilNITE (TM). Three models are available.

The basic model quickMOUNT is for mounting small point to point and sector antennas. It is possible to simultaneously mount two SXTs, thus creating a repeater access point or creating large sector coverage.

The advanced model quickMOUNT extra can be used for our long range heavy antennas like 30dBi parabolic dish mANT 30 or 19dBi sector mANT 19s. Both quickMOUNT and quickMOUNT extra gives possibility to turn antenna horizontally within 190°.

The quickMOUNT pro makes it possible to turn antenna within 140° both in horizontal and vertical plane. With the quickMOUNT pro it is possible to perfectly set antenna alignment using integrated graduated scale.

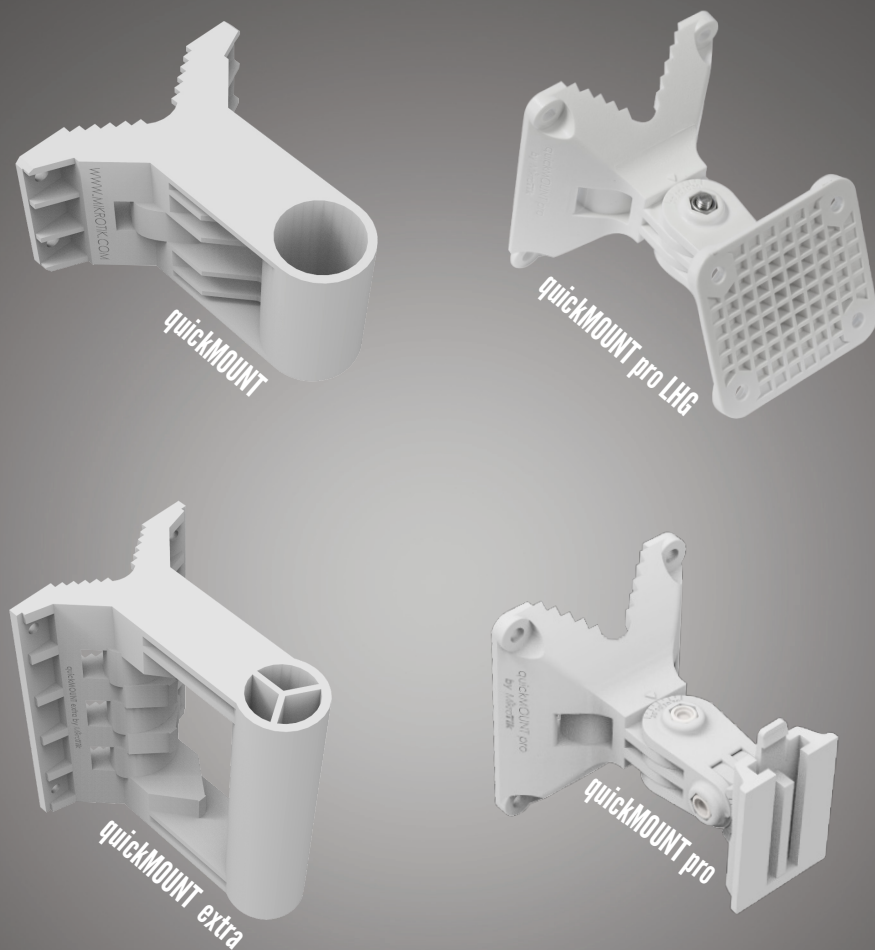

Mounting ring

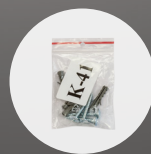

K-41 screw kit

Model	quickMOUNT	quickMOUNT pro	quickMOUNT pro LHG	quickMOUNT extra
Product code	QM	QMP	QMP-LHG	QME
Dimensions	96x107.5x56 mm	95x88x112mm		102x135x150mm
Tube diameter	35 mm			
Max tube diameter to which mount can be attached	65 mm			70mm
Maximum antenna weight	1.5 kg			8kg
Maximum wind load	100N			
Compatible devices	SXT series, Omnitik, 3rd party antennas that are designed to be pole mounted		QMP: SXT, Omnitik, other antennas that are designed to be pole mounted QMP-LHG: LHG 5	Any pole mounted antenna with weight under 8kg
Turn angle for MikroTik products	190°	140°		190°
Operational temperature range	±40° C			
Material	anvilNITE™			
Included	quickMOUNT, metal ring, K-41 screw kit			

R52HnD

The R52HnD is an update to our popular miniPCI wireless card. It works in either 2.4 or 5GHz and is now even higher power (400mW).

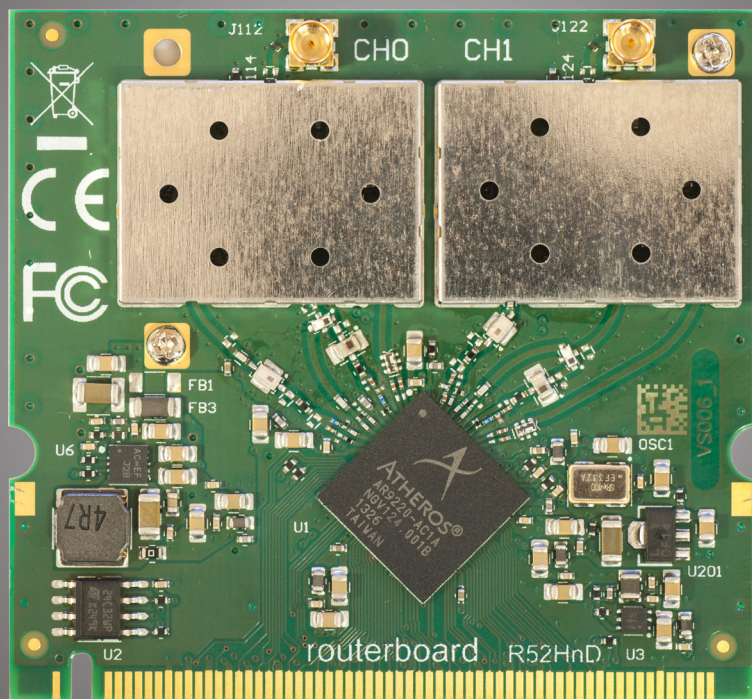

Product code	R52HnD
Chipset	AR9220
Wireless	2.4 / 5GHz (selectable)
Frequency range	2200-2700 or 4800-6100 MHz
Standards	802.11a/b/g/n
Max output power	400mW
Format	miniPCIe
Dimensions	60 x 55 x 7mm
Connectors	2x MMCX
Supported channels	20/40 MHz
Temperature	-40°C .. +70°C tested
MAX power consumption	7W

Rate (2.4 GHz)	Tx	Rx
1MBit/s	26	-100
11MBit/s	26	-94
6MBit/s	26	-96
54MBit/s	25	-80
MCS0	23	-96
MCS7	23	-78

Rate (5 GHz)	Tx	Rx
6MBit/s	26	-96
54MBit/s	25	-80
MCS0	23	-96
MCS7	21	-78

Wireless miniPCI cards

We are offering wide range of miniPCI wireless cards for expansions, covering from 2.192GHz up to 6.100GHz, with output power from 50mW up to 1600mW.

We have a cards that features built-in LED indicators for wireless mode, connection status (connected, searching, disabled), TX and RX activity and wireless signal strength - just looking at the card will help with installation and alignment.

See the tables for more information on specifications.



Model	R5SHPn		R2SHPn		R52H		R52n-M	
802.11a	RX	TX	RX	TX	RX	TX	RX	TX
6Mbit	-93	29dBm	-	-	-90	24dBm	-97/-95	21dBm
54Mbit	-77	25dBm	-	-	-70	19dBm	-80/-79	19dBm
802.11b	RX	TX	RX	TX	RX	TX	RX	TX
1Mbit	-	-	-93	32dBm	-92	25dBm	-95/-94	23dBm
11Mbit	-	-	-77	30dBm	-87	25dBm	-92	23dBm
802.11g	RX	TX	RX	TX	RX	TX	RX	TX
6Mbit	-	-	-93	32dBm	-90	25dBm	-95/-94	25dBm
54Mbit	-	-	-77	29dBm	70	20dBm	-80	21dBm
802.11n 2.4GHz	RX	TX	RX	TX	RX	TX	RX	TX
MCS0 20MHz	-	-	-93	32dBm	-	-	-95/-94	23dBm
MCS0 40MHz	-	-	-93	31dBm	-	-	-91	21dBm
MCS7 20MHz	-	-	-74	28dBm	-	-	-77	20dBm
MCS7 40MHz	-	-	-72	27dBm	-	-	-74	20dBm
802.11n 5GHz	RX	TX	RX	TX	RX	TX	RX	TX
MCS0 20MHz	-93	28dBm	-	-	-	-	-97/-95	21/19
MCS0 40MHz	-89	29dBm	-	-	-	-	-93/-91	19
MCS7 20MHz	-74	24dBm	-	-	-	-	-78/-76	16
MCS7 40MHz	-71	24dBm	-	-	-	-	-75/-73	13

Model	R5SHPn	R2SHPn	R52H	R52n-M
Chipset	Atheros AR9220	Atheros AR9223	Atheros AR5414	Atheros AR9220
Frequency range (MHz)	4800-6075	2192-2539	4920-6100 2192-2539	4800-6100 2200-2700
Standards	802.11a/n	802.11b/g/n	802.11a/b/g	802.11a/b/g/n
Max output power	800mW	1600mW	316mW	316mW
Format	miniPCI			
Dimensions	60x60x19mm (incl. heatsink)	60x60x19mm (incl. heatsink)	60x45x3mm	60x45x
Connectors	1x MMCX (single chain)	1x MMCX (single chain)	Two U.fl connectors	2 X MMCX Antenna Connector
Features	9 LED indicators, ESD protection	9 LED indicators, ESD protection		
Temperature	Starting -5°C to +65°C Operating -30°C to +65°C	Starting -5°C to +65°C Operating -30°C to +65°C	Operating -20°C to +70°C	Operating -20°C to +60°C
Power consumption	Up to 10W at maximum power	Up to 10W at maximum power	3.5W	Max:2.4W

R11e series

High power wireless cards in miniPCI-e format. Ideally suited for our products with miniPCIe slots to add another wireless interface.

The card features built-in LED indicators for wireless mode, connection status (connected, searching, disabled), TX and RX activity and wireless signal strength - just looking at the card will help with installation and alignment.

Five models are available:

R11e-2HnD (2GHz, uFL connector, small heatsink)

R11e-2HPnD (2GHz, MMCX, high output power, larger heatsink)

R11e-5HnD (5GHz, MMCX, larger heatsink)

R11e-5HacD (5GHz, 802.11ac, MMCX, larger heatsink)

R11e-5HacT (5GHz, 802.11ac, MMCX, triple chain, larger heatsink)

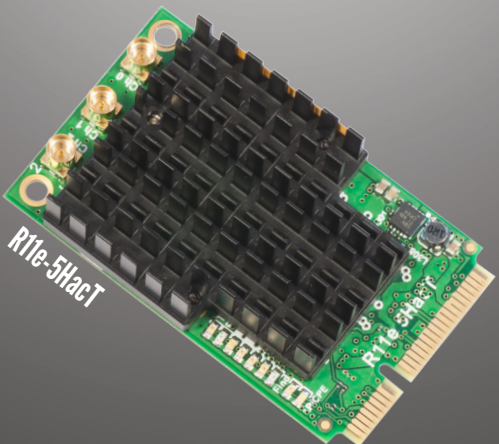
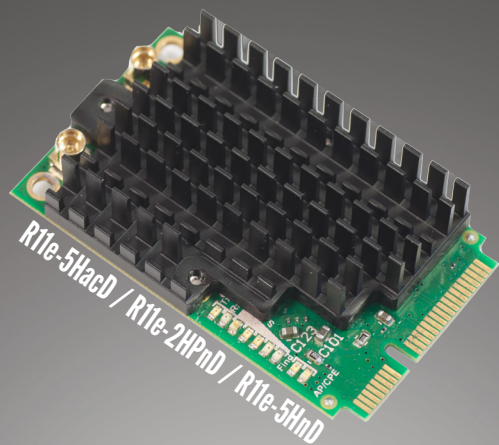

Model	2HnD	2HPnD	5HnD	5HacD	5HacT
Chipset	AR9580			QCA9882	QCA9880
Frequency range	2312-2732 MHz		4920-6100MHz		
Standards	802.11b/g/n	802.11b/g/n	802.11a/n	802.11ac	
Max output power	800mW	1000mW	500mW	630 mW	
Format	miniPCIe				
Dimensions	51x30x6mm	51x30x13mm			
Connectors	2x uFL	2x MMCX		3x MMCX	
Features	9 LED indicators, ESD protection				
Supported channels	20/40MHz			20/40/80MHz	
Temperature	Starting -5°C to +65°C; Operating -40°C to +70°C				
MAX power consumption	5W	7W	5W	4.5W	5 W
TX/RX at MCS0	29dBm / -96dBm	30dBm / -96dBm	26dBm / -96dBm	26dBm / -96dBm	28dBm / -96dBm
TX/RX at MCS7	24dBm / -76dBm	24dBm / -76dBm	23dBm / -76dBm	23dBm / -77dBm	27dBm / -77dBm
TX/RX at 6Mbit	29dBm / -96dBm	30dBm / -96dBm	27dBm / -96dBm	27dBm / -96dBm	28dBm / -96dBm
TX/RX at 54Mbit	24dBm / -80dBm	24dBm / -80dBm	24dBm / -80dBm	23dBm / -81dBm	28dBm / -81dBm

48V Gigabit PoE converter

This device lets you use any 48V PoE source (including Passive PoE, Telecom PoE, 802.3af and 802.3at) to power RouterBOARD devices.

Simply plug any 48V PoE powered ethernet cable into one port, and any 8-30V capable RouterBOARD device into the other. This device is capable to provide high power output - up to 24W (up to 1A at 24V).

You can power it with virtually any 36-57V PoE solutions available on market today (Passive, Telecom, 802.3af and 802.3at PoE plus supported)

The device is a rugged metallic design, with high capacity components and integrated heatsink design. The case also has mounting holes so you can attach it to a wall.

Ethernet shield pins are inside the Ethernet connectors, so that shielded ethernet can be used, to ground either at the converter itself, or at the devices at both ends.

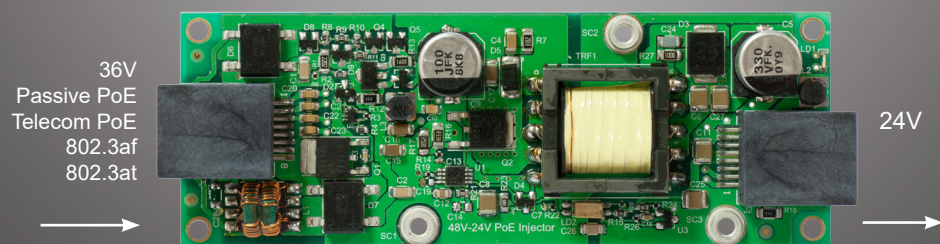
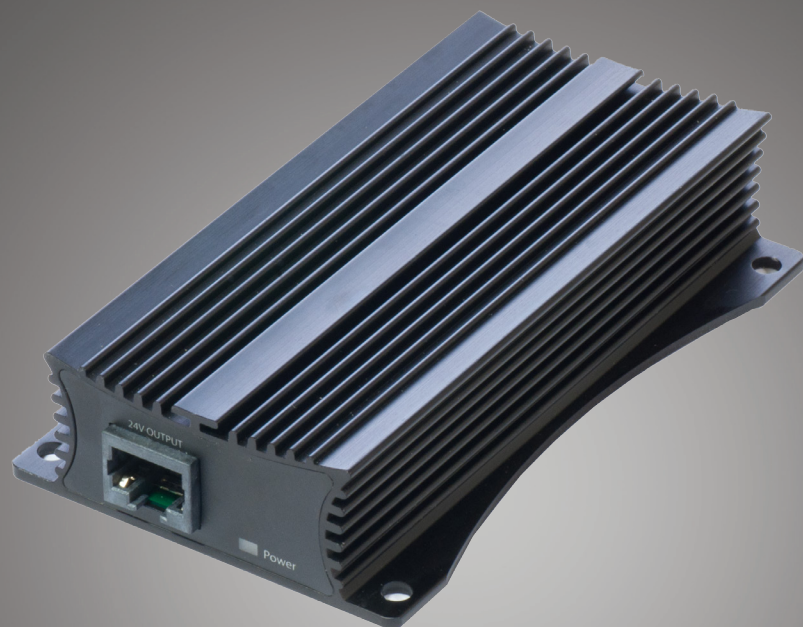

Name	RouterBOARD POE-CON-HP
Ethernet	Two Gigabit Ethernet ports with grounding pins - one input, one output.
Dimensions	107x66x24mm
Power Input	36-57V (Passive, Telecom, 802.3af and 802.3at PoE plus supported)
Power Output	24V 1A
Output pins	4,5 "+"; 7,8 "-"

SFP transceivers

To complement our SFP cage equipped devices, several types of SFP modules are available for the most popular SFP use scenarios.

We currently offer two SFP 1.25G modules, one SFP 1.25G module kit, two SFP+ 10G modules, one SFP+ 10G module kit, two Direct Attach cable kits and one SFP to RJ45 fiber to copper module.



Model	Specifications
S-85DLC05D	1.25G, 850nm Dual LC connector, 550m, MM, DDMI
S-31DLC20D	1.25G, 1310nm Dual LC connector, 20km, SM, DDMI
S-3553LC20D two module kit	S-35LC20D: 1.25G SM, 20km, T1310nm/R1550nm, LC, DDMI S-53LC20D: 1.25G SM, 20km, T1550nm/R1310nm, LC, DDMI
S+85DLC03D	SFP+ module 10G MM 300m 850nm LC-connector DDMI
S+31DLC10D	SFP+ module 10G SM 10km 1310nm LC-connector, DDMI
S+2332LC10D two module kit	S+23LC10D: 10G, SM, 10KM, Tx:1270nm Rx:1330nm, LC, DDMI S+32LC10D: 10G, SM, 10KM, Tx:1330nm Rx:1270nm, LC, DDMI
S-RJ01	RJ45 SFP 10/100/1000M copper module
S+DA0001	1m, connects two SFP/SFP+ devices
S+DA0003	3m, connect two SFP/SFP+ devices

GPON ONT module

The GPON module allows any RouterBOARD device to be used for Fiber to Home installations without any special modems or software. A plug and play solution means you simply plug it into your device, and no special configuration is needed. It is supported by all our SFP products, with any RouterOS version - all configuration will be done on the ISP side.

This module is a G.984.5 Optical Network Terminal (ONT) with Small Form-factor Pluggable (SFP) packaging. The module integrates a bi-directional optical transceiver function and GPON MAC function. By being plugged into the customer premise equipment (CPE) with standard SFP port directly, the GPON provides an asymmetric 1.244Gbps upstream 2.488 Gbps downstream GPON uplink to the CPE without requiring separate power supply.

It supports a sophisticated ONT management system, including alarms, provisioning, DHCP and IGMP functions for a stand-alone IPTV solution at the ONT, Time of Day and 1PPS interface. The GPON ONU module can be managed from the OLT over the GPON using G.988 OMCI.

It fits seamlessly into existing communications equipment, providing service providers with a smooth upgrade to GPON. The GPON solution vastly decreases the installation costs of deploying fiber access in MDUs and enables service providers to improve their revenue streams while decreasing OPEX.

Specifications

- Simplex SC Connector, Integrated Diplexer Transceiver
- SFP MSA, digital diagnostics SFF-8472 Compliant
- Compliant to FSAN G.984.5 Specifications
- 1244 Mbps Tx, 2488 Mbps Rx Asymmetric Data Rate
- Operating case temperature: 0~70°C
- Subscriber location identifier (SLID)
- PON Link Status notification
- Dying Gasp notification
- Supports Time of Day and 1PPS interface
- Response the TX power shut-down command from OLT when OLT detect anomaly
- TC Layer GEM encapsulation mode
- OMCI support per ITU-T G.988
- 28 dB link budget; Class B+, 20 km reach
- Compliant to IEC-60825 Class 1 laser diode
- RoHS compliant
- Internal Calibration



FTC

The FTC is a Fiber to Copper converter. Unlike many other media converters available on market, FTC has an outdoor waterproof case with lock screw. The device supports 12-57V PoE with 802.3af/at support. Comes with PoE injector and power supply. The case has a mounting system that is secured by a screw from inside the lockable case, making the device hard to access by unauthorised people.

- PoE support
- Outdoor fully weather proof wall/pole/din mounting
- Supports 1.25G 1000Base-X fiber to FE/GigE copper

Power	12-57V Passive or 802.3af PoE
Operating temperature	-40 to +70C
Ethernet	One 10/100/1000Mbit ethernet connector with PoE input support
Dimensions	185x85x30 mm
SFP	One 1.25Gbit port (SFP module not included)



Flex-guide

super low loss cable assembly

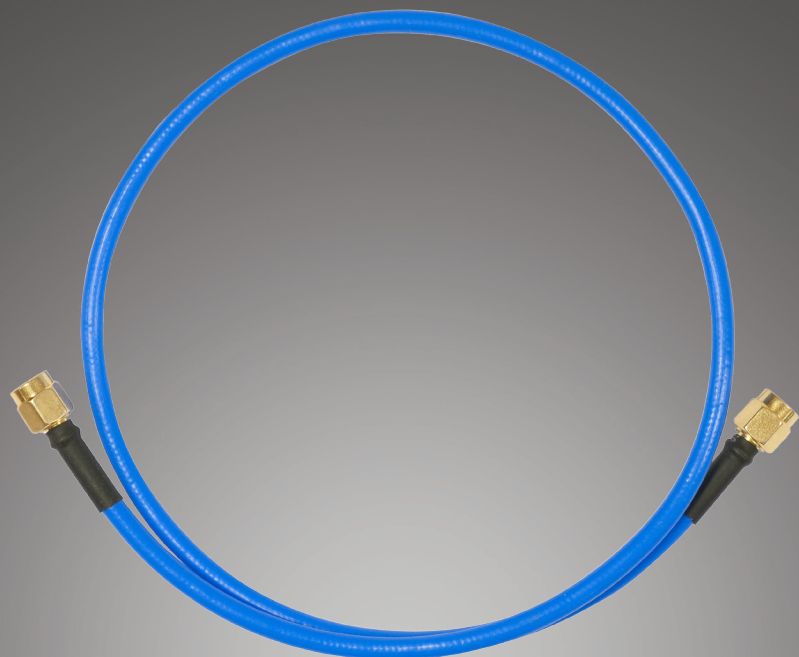

A super low loss RPSMA cable for superior connection quality, suited for indoor and outdoor use, this cable provides superior matching and loss values.

The name of this cable comes from combining the words “flexible” and “waveguide”, to denote the high end features of this product.

The inner conductor is silver plated copper, and both connectors are soldered, not crimped, for the best possible signal quality. Ideally suited for our BaseBox and other products with RPSMA connectors, and works with most antennas.

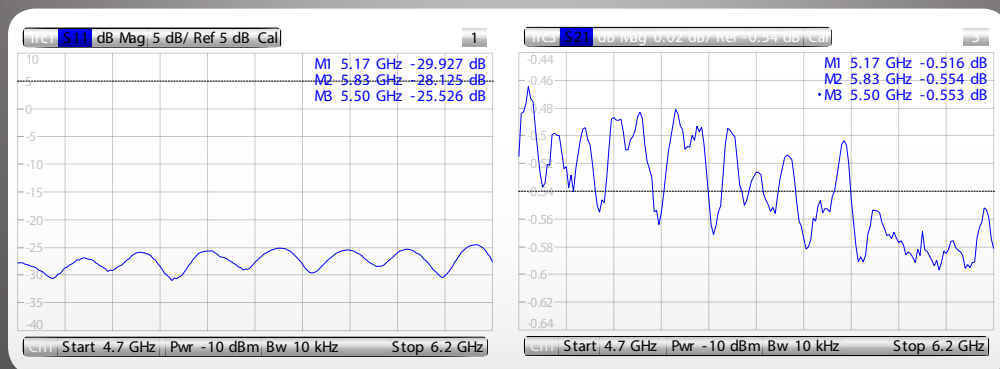
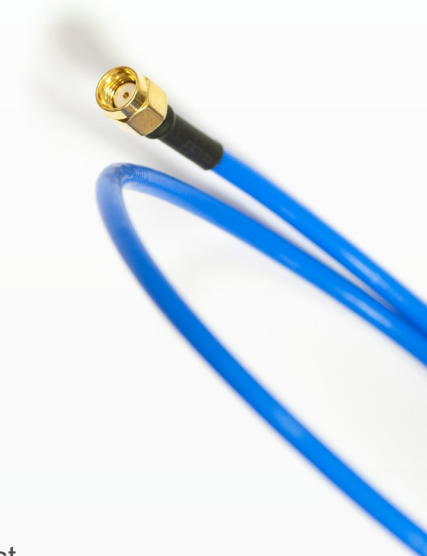

Product order code	ACRPSMA
RPSMA	Soldered on both ends
Connector type	RP-SMA Male (inside thread)
Inner conductor	Silver plated copper
Frequency	up to 6 GHz
Total signal loss at 6GHz	0.59 (Includes connectors. See chart for details)
Matching	Better than -20dB
Suited for	outdoor use
Cable length	500mm (19.7")
Outer diameter	4.2mm (0.2")
Min. bending radius static	8mm (0.3")
Min. bending radius repeated	40mm (1.6")
Operating temperature	-55 to 125C



To obtain MikroTik hardware and software, visit our distributors.
For more information and latest news go to
routerboard.com and mikrotik.com